

Shenzhen Big Tree Technology CO.,LTD .
BIG TREE TECH

SHENZHEN BIG TREE TECHNOLOGY
CO.,LTD .
BIGTREETECH

BIGTREETECH
TMC5160 PRO-V1.1
User Manual

1.Introduction

TMC5160 is a control chip of high-power stepper motor with MOS power expansion, 20A maximum current and low heat generation.

StealthChop2 mode for TRINAMICs eliminates motor noise by reducing resonance. StallGuard2 filament blockage detection enables stepper motor torque control or back to zero without a sensor, which is a safe detection of motor stopping and the replacement of mechanical stop switch. DcStep allows the motor to run near its load limit and speed limit, achieving 10x or higher range without any pulse loss. SpreadCycle is high precision chopping algorithm for highly dynamic motor motion and generating absolutely clean current waves. Low noise, low resonance and low vibration chopper. CoolStep current control optimizes driver performance and energy efficiency, enables smooth and silent drive, balances speed and motor torque, reduces energy consumption by 75 %.

TMC5160 is an upgrade of TMC2100, TMC2130 and TMC5130 series, with higher voltage and motor currents.

2.Product Parameters

Driver Chip: TMC5160-WA;

Product Size: 15.3mm*20.4mm;

Supply Voltage: 8V---56V;

Maximum Current: 3A

(maximum current of 2.54 single-row pins-3A)

Maximum Segmentation: 256;

Working Mode: SPI Mode, SD Mode

3. Advantages

- 1、 External power MOS tube, for higher current
- 2、 Ultra-silent mode
- 3、 Less motor jittering
- 4、 less pulse loss
- 5、 It is able to drive 57 stepper motor

4.Pins Instruction

4.1、Names of pins

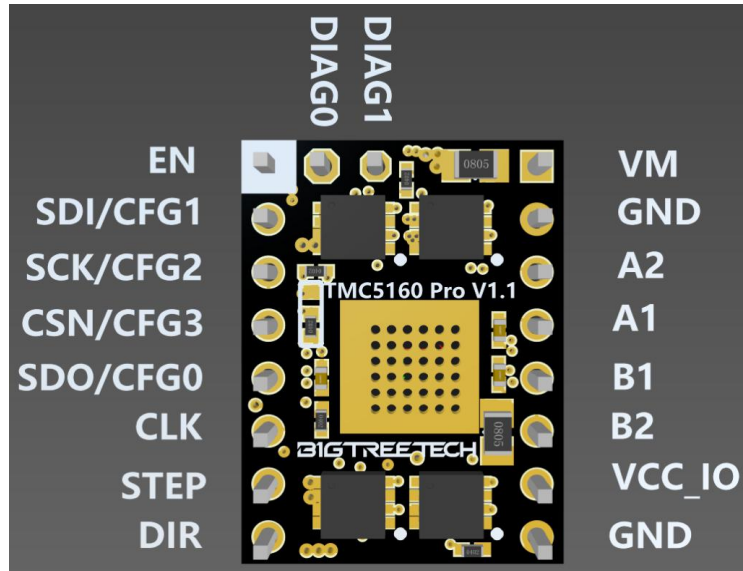

4.2、Functions of pins

J1	Functions	J2	Functions
1	EN	1	VM
2	SDI/CFG1	2	GND
3	SCK/CFG2	3	A2
4	CSN/CFG3	4	A1
5	SDO/CFG0	5	B1
6	CLK	6	B2
7	STEP	7	VCC_IO
8	DIR	8	GND

4.3、Product Size

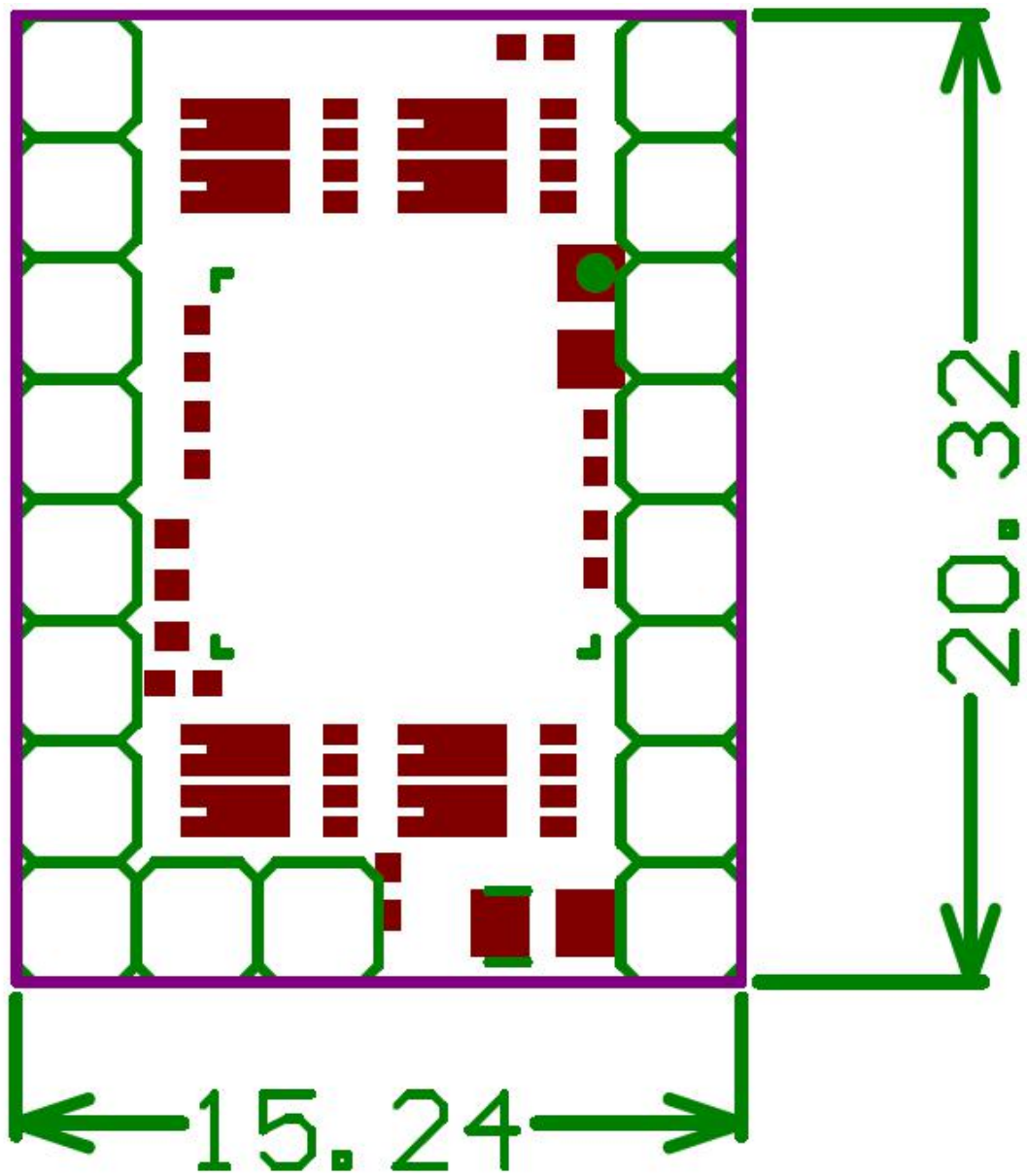

5.Driver installation

The pins with white boxes on the driver are enable
(EN) pins:

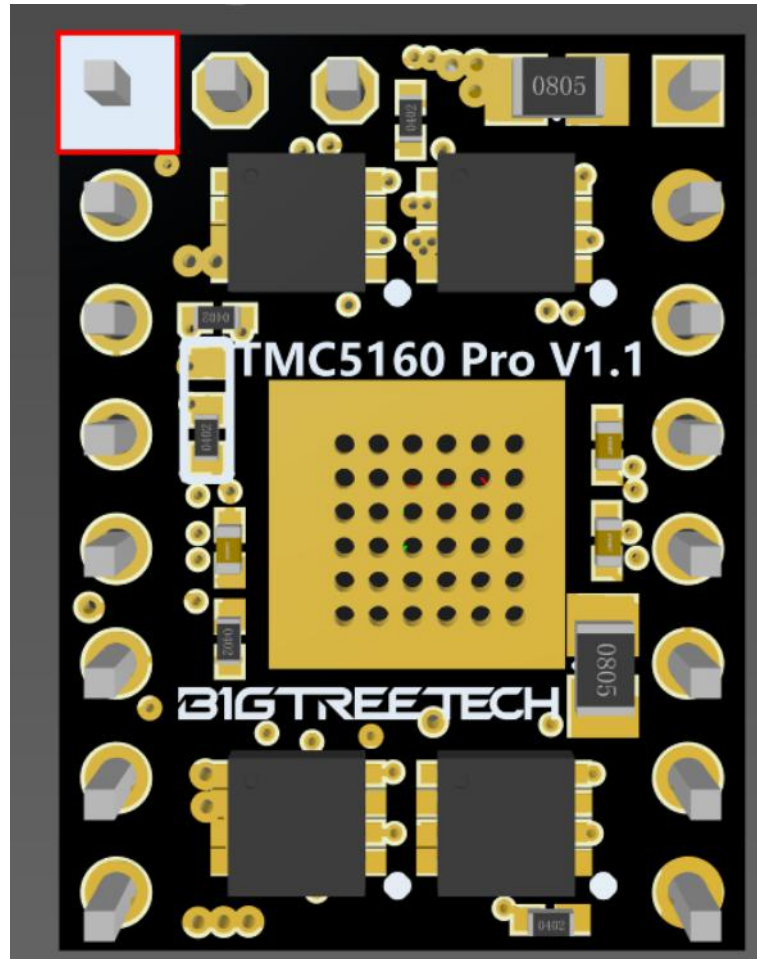

6.SD_MODE

The factory default mode SD_MODE = 1 , the STEP / DIR input pins control the driver as shown:



To use SD_MODE =0,
step signal is made by internal ramp generator
the resistor is welded to the other side as shown:

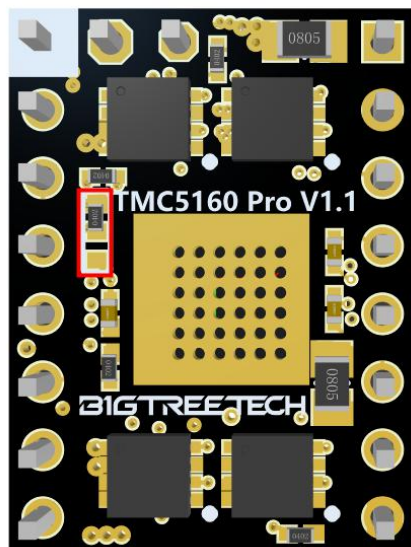

7.Heat dissipation

It is recommended to add active heat dissipation to the TMC5160 Pro When the current is over 1A.

With an 12V/5V LDO inside, excessive differential pressure brings more heat. It is recommended to add active heat dissipation to the TMC5160 Pro to ensure the stability of the printing system when the voltage is higher than 40V.

8. Firmware Configuration

1. Marlin

a. Set the driver as TMC5160 in Configuration.h

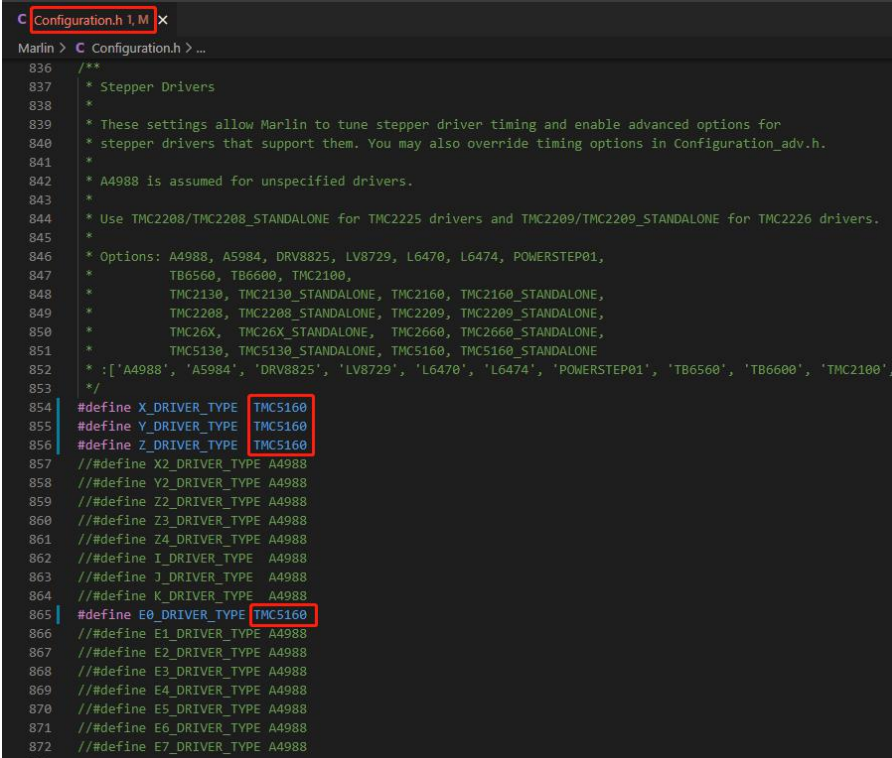

```
C Configuration.h 1, M x
Marlin > C Configuration.h > ...
836 /**
837  * Stepper Drivers
838  *
839  * These settings allow Marlin to tune stepper driver timing and enable advanced options for
840  * stepper drivers that support them. You may also override timing options in Configuration_adv.h.
841  *
842  * A4988 is assumed for unspecified drivers.
843  *
844  * Use TMC2208/TMC2208_STANDALONE for TMC2225 drivers and TMC2209/TMC2209_STANDALONE for TMC2226 drivers.
845  *
846  * Options: A4988, A5984, DRV8825, LV8729, L6470, L6474, POWERSTEP01,
847  *          TB6560, TB6600, TMC2100,
848  *          TMC2130, TMC2130_STANDALONE, TMC2160, TMC2160_STANDALONE,
849  *          TMC2208, TMC2208_STANDALONE, TMC2209, TMC2209_STANDALONE,
850  *          TMC26X, TMC26X_STANDALONE, TMC2660, TMC2660_STANDALONE,
851  *          TMC5130, TMC5130_STANDALONE, TMC5160, TMC5160_STANDALONE
852  * :['A4988', 'A5984', 'DRV8825', 'LV8729', 'L6470', 'L6474', 'POWERSTEP01', 'TB6560', 'TB6600', 'TMC2100',
853  */
854 #define X_DRIVER_TYPE  TMC5160
855 #define Y_DRIVER_TYPE  TMC5160
856 #define Z_DRIVER_TYPE  TMC5160
857 //#define X2_DRIVER_TYPE A4988
858 //#define Y2_DRIVER_TYPE A4988
859 //#define Z2_DRIVER_TYPE A4988
860 //#define Z3_DRIVER_TYPE A4988
861 //#define Z4_DRIVER_TYPE A4988
862 //#define I_DRIVER_TYPE A4988
863 //#define J_DRIVER_TYPE A4988
864 //#define K_DRIVER_TYPE A4988
865 #define E0_DRIVER_TYPE TMC5160
866 //#define E1_DRIVER_TYPE A4988
867 //#define E2_DRIVER_TYPE A4988
868 //#define E3_DRIVER_TYPE A4988
869 //#define E4_DRIVER_TYPE A4988
870 //#define E5_DRIVER_TYPE A4988
871 //#define E6_DRIVER_TYPE A4988
872 //#define E7_DRIVER_TYPE A4988
```

b. If there is independent SPI port, set TMC_USE_SW_SPI in Configuration_adv.h

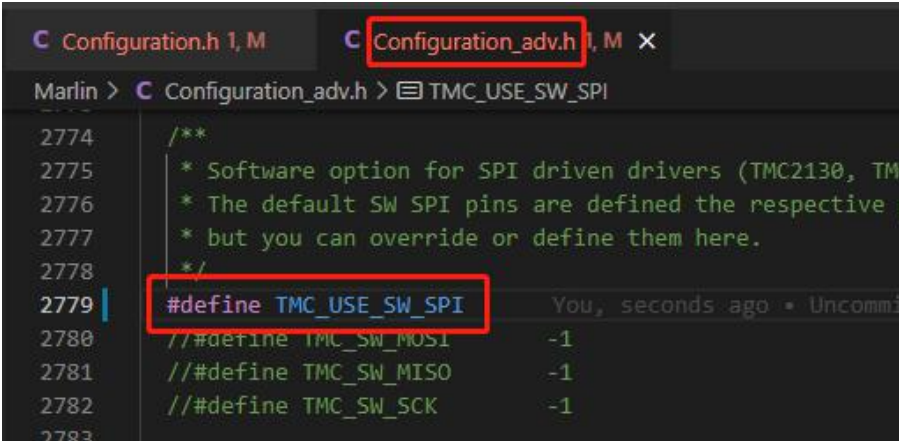

```
C Configuration.h 1, M x  C Configuration_adv.h 1, M x
Marlin > C Configuration_adv.h > TMC_USE_SW_SPI
2774 /**
2775  * Software option for SPI driven drivers (TMC2130, TMC
2776  * The default SW SPI pins are defined the respective p
2777  * but you can override or define them here.
2778  */
2779 #define TMC_USE_SW_SPI  You, seconds ago * Uncommi
2780 //#define TMC_SW_MOSI  -1
2781 //#define TMC_SW_MISO  -1
2782 //#define TMC_SW_SCK   -1
2783
```

Shenzhen Big Tree Technology CO.,LTD .
BIG TREE TECH

c. If the motherboard needs custom pins, customize the CS signal lines in the “pins_xxx.h” and the SPI signal lines in “Configuration_adv

```
C Configuration.h 1, M C Configuration_adv.h 1, M C pins_BTT_OCTOPUS_V1_common.h 8 x
Marlin > src > pins > stm32f4 > C pins_BTT_OCTOPUS_V1_common.h > ...
153 //
154 #define X_STEP_PIN PF13 // MOTOR 0
155 #define X_DIR_PIN PF12
156 #define X_ENABLE_PIN PF14
157 #ifndef X_CS_PIN
158 #define X_CS_PIN PC4
159 #endif
160
161 #define Y_STEP_PIN PG0 // MOTOR 1
162 #define Y_DIR_PIN PG1
163 #define Y_ENABLE_PIN PF15
164 #ifndef Y_CS_PIN
165 #define Y_CS_PIN PD11
166 #endif
167
168 #define Z_STEP_PIN PF11 // MOTOR 2
169 #define Z_DIR_PIN PG3
170 #define Z_ENABLE_PIN PG5
171 #ifndef Z_CS_PIN
172 #define Z_CS_PIN PC6
173 #endif
174
175 #define Z2_STEP_PIN PG4 // MOTOR 3
176 #define Z2_DIR_PIN PC1
177 #define Z2_ENABLE_PIN PA0
178 #ifndef Z2_CS_PIN
179 #define Z2_CS_PIN PC7
180 #endif
181
182 #define E0_STEP_PIN PF9 // MOTOR 4
183 #define E0_DIR_PIN PF10
184 #define E0_ENABLE_PIN PG2
185 #ifndef E0_CS_PIN
186 #define E0_CS_PIN PF2
187 #endif
188
189 #define E1_STEP_PIN PC13 // MOTOR 5
190 #define E1_DIR_PIN PF0
191 #define E1_ENABLE_PIN PF1
192 #ifndef E1_CS_PIN
193 #define E1_CS_PIN PE4
194 #endif
195

C Configuration.h 1, M C Configuration_adv.h 1, M x C pins_BTT_OCTOPUS_V1_common.h 8
Marlin > C Configuration_adv.h > ...
2774 /**
2775 * Software option for SPI driven drivers (TMC2130, TMC2160, TMC2660, TMC5130 and TMC5160).
2776 * The default SW SPI pins are defined the respective pins files,
2777 * but you can override or define them here.
2778 */
2779 #define TMC_USE_SW_SPI
2780 #define TMC_SW_MOSI PA7
2781 #define TMC_SW_MISO PA6
2782 #define TMC_SW_SCK PA5
```

Shenzhen Big Tree Technology CO.,LTD .
BIG TREE TECH

d. Set the sampling resistance to 0.075 (the sampling resistance value of the driver is 0.075), and set the current and subdivision according to your own needs.

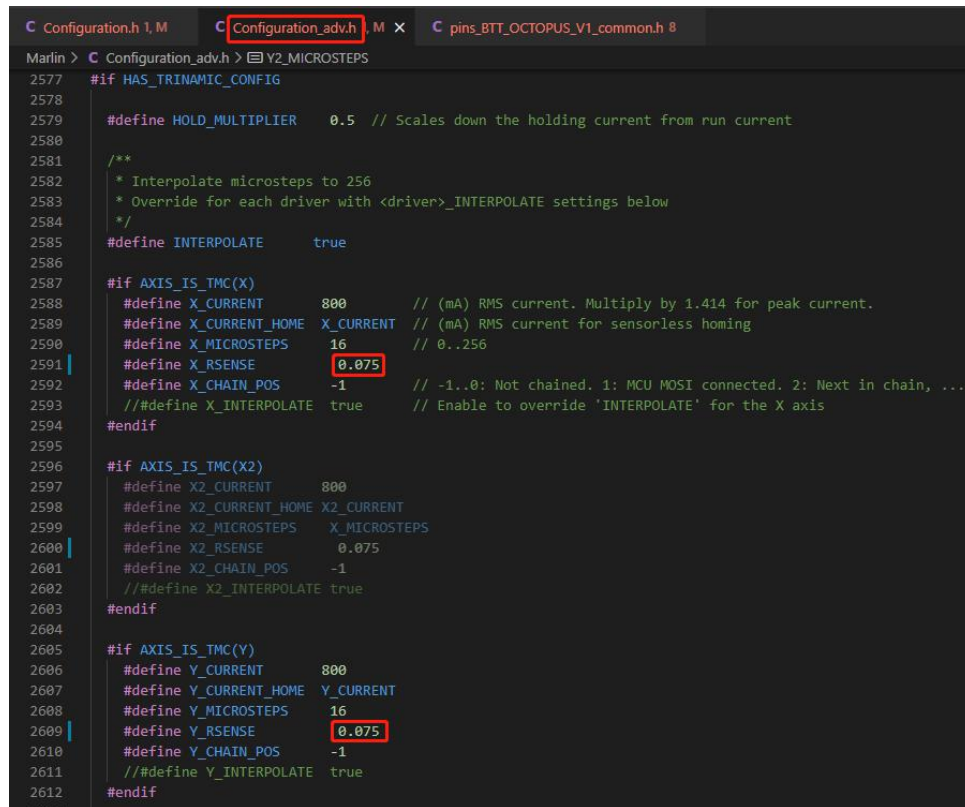

```
Configuration.h 1, M | Configuration_adv.h | M x | pins_BTT_OCTOPUS_V1_common.h 8
Marlin > C Configuration_adv.h > Y2_MICROSTEPS
2577 #if HAS_TRINAMIC_CONFIG
2578
2579 #define HOLD_MULTIPLIER 0.5 // Scales down the holding current from run current
2580
2581 /**
2582  * Interpolate microsteps to 256
2583  * Override for each driver with <driver>_INTERPOLATE settings below
2584  */
2585 #define INTERPOLATE true
2586
2587 #if AXIS_IS_TMC(X)
2588 #define X_CURRENT 800 // (mA) RMS current. Multiply by 1.414 for peak current.
2589 #define X_CURRENT_HOME X_CURRENT // (mA) RMS current for sensorless homing
2590 #define X_MICROSTEPS 16 // 0..256
2591 #define X_RSENSE 0.075
2592 #define X_CHAIN_POS -1 // -1..0: Not chained. 1: MCU MOSI connected. 2: Next in chain, ...
2593 // #define X_INTERPOLATE true // Enable to override 'INTERPOLATE' for the X axis
2594 #endif
2595
2596 #if AXIS_IS_TMC(X2)
2597 #define X2_CURRENT 800
2598 #define X2_CURRENT_HOME X2_CURRENT
2599 #define X2_MICROSTEPS X_MICROSTEPS
2600 #define X2_RSENSE 0.075
2601 #define X2_CHAIN_POS -1
2602 // #define X2_INTERPOLATE true
2603 #endif
2604
2605 #if AXIS_IS_TMC(Y)
2606 #define Y_CURRENT 800
2607 #define Y_CURRENT_HOME Y_CURRENT
2608 #define Y_MICROSTEPS 16
2609 #define Y_RSENSE 0.075
2610 #define Y_CHAIN_POS -1
2611 // #define Y_INTERPOLATE true
2612 #endif
2613
```

2. Klipper

Set the current and subdivision according.

For more details, please refer to

[https://www.klipper3d.org/Config Reference.html#tmc5160](https://www.klipper3d.org/Config%20Reference.html#tmc5160)

```
printer.cfg X
C: > Users > Administrator > Desktop > Canbus-Toolboard > printer.cfg
359
360 [tmc5160 stepper_x]
361 cs_pin: PC4
362 sense_resistor: 0.075
363 interpolate: True
364 run_current: 1.5
365 hold_current: 0.5
366 stealthchop_threshold: 0
367 spi_bus: spi1
368 #diag1_pin: !PG6 # Pin connected to TMC DIAG1 pin (or use diag0_pin / DIAG0 pin)
369 #driver_SGT: 2 # -64 is most sensitive value, 63 is least sensitive
370 #driver_TPFD: 0
371 #driver_TOFF: 4
372 #driver_HEND: 2
373 #driver_HSTRT: 1
374 #driver_DISS2G: 12
375 #driver_DISS2VS: 12
376
377
378 [tmc5160 stepper_y]
379 cs_pin: PD11
380 sense_resistor: 0.075
381 interpolate: True
382 run_current: 1.5
383 hold_current: 0.5
384 stealthchop_threshold: 0
385 spi_bus: spi1
386 #diag1_pin: ^!PG9 # Pin connected to TMC DIAG1 pin (or use diag0_pin / DIAG0 pin)
387 #driver_SGT: 3 # -64 is most sensitive value, 63 is least sensitive
388 #driver_TPFD: 0
389 #driver_TOFF: 4
390 #driver_HEND: 2
391 #driver_HSTRT: 1
392 #driver_DISS2G: 12
393 #driver_DISS2VS: 12
394
```

9.Caution

- 1、 Disconnect the power supply before driver installation.
- 2、 Confirm the direction of driver to avoid reverse insertion.
- 3、 Do not plug and unplug the driver module when power is on to avoid damage.
- 4、 Please note that the heat sink cannot contact with the pins to prevent the driver from short circuit.
- 5、 TMC5160 is sensitive to static electricity, please be careful.
- 6、 It is recommended to add the active heat dissipation when using higher current or higher voltage.
- 7、 No touching after power on to avoid accident (especially when the power input is 36V or higher.)

10. Download link

<https://github.com/bigtreotech/BIGTREETECH-Stepper-Motor-Driver>