

年Y月M日D	更正记事 ECN RECORD	版本REV
2024/12/16	首版发行	A



## Dear User

Thank you for choosing UniFormation products!

For the best experience, please read this manual carefully before starting to print and familiarize yourself with the operation, precautions, and usage tips of the machine to better install and use it.

To help you start your 3D printing journey, please note the following information:

1. The USB flash drive included in the packaging contains the machine's software, authorized model files, assembly and usage tutorial videos, and the manual.
2. If you encounter any issues not covered in this manual while using the machine, please contact customer service or email us at support@uniformalion3d.com, and we will do our best to assist you.

\*Note: The copyright of this manual belongs to Zhongshan Huayu Yuanxing Electronic Technology Co., Ltd. Reprinting is prohibited without permission.

Thank you!  
The UniFormation Team.

## Contents

1. Precautions Before Use	03
2. Product Overview	03-04
3. Packing List	04
4. Product Specifications	05
5. Setup and Operational Checks	06-08
6. Operational Interface Introduction	09-13
7. Functions Overview	14-18
8. First Printing Instructions	22-23
9. FAQ and Maintenance	24











02

成品尺寸:148\*210mm  
 装钉方式:骑马钉(24p)  
 四色双面印刷  
 印刷克数:100g双胶纸(封面封底),内页80g

<b>UNIFORMATION</b>   中山华煜远行电子科技有限公司 Zhongshan Huayu Yuanxing Electronic Technology Co., Ltd					
品名 PART NAME	GK3指导说明书		更新 UPDATE	2024/12/16	
料号 P/N	02315		设计 DESIGN	Melissa	
页数 PAGE	1/1	客户代码 Client NO.	/	版本 REV	A1
数量 QUANTITY	1件/套	校对 CHECK	/	比例 PROPORTION	1:1
重量 WEIGHT	/	核准 APPR.	/	单位 UNIT	MM

# 1. Precautions Before Use

Always follow the safety instructions during assembly and use to avoid unnecessary damage or injury.

	After receiving the items, if any accessories are missing, please contact customer service for replacements before use.		Be cautious when using the scraper. Always scrape away from the body and hands.
	In case of emergency, immediately shut off the power to the printer.		There are moving parts inside the printer. Please do not touch any parts inside the machine while it is in use.
	Safety glasses and gloves should be worn as personal protective equipment (PPE).		Keep the printer and its accessories out of the reach of children. Keep uncured resin out of the reach of children.
	The optimal environmental temperature range is 8°C to 40°C, with relative humidity between 20% and 50%. Using outside this range may result in printing failures.		When the machine is not in use for an extended period, please protect it from rain and moisture.
	Please use the printer in a spacious, flat, and well-ventilated area.		If printing fails, please clear the cured resin in the resin vat to avoid damaging the printer.

# 2. Product Overview

## Machine Structure Instruction

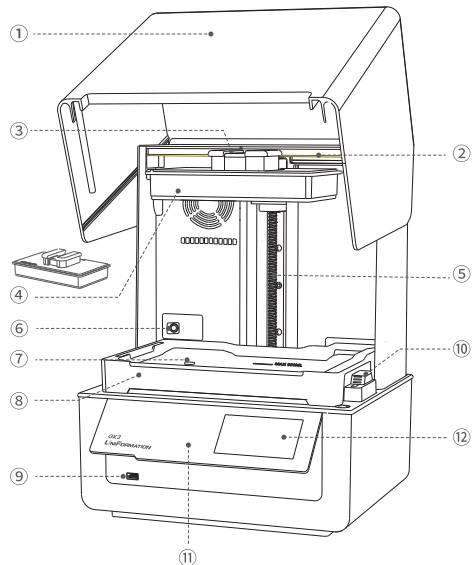



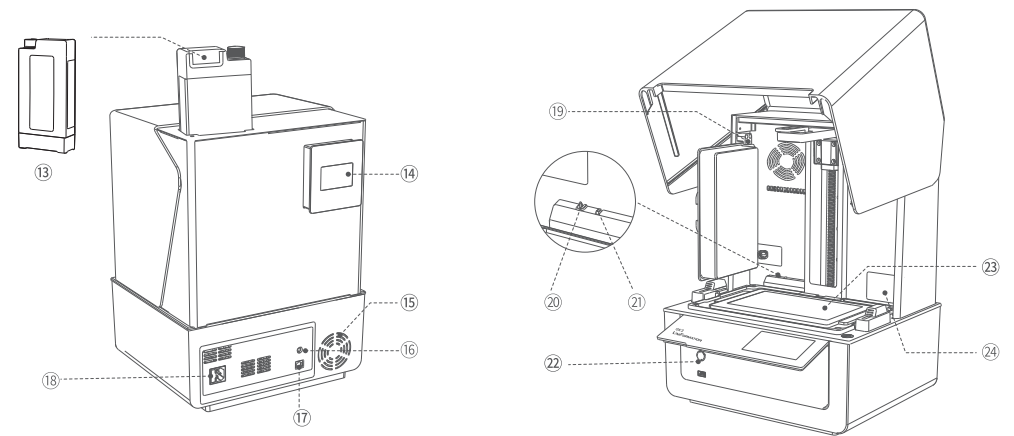





- ① Flip cover
- ② Lighting lamp: Provides auxiliary lighting for the machine
- ③ Platform fixing handle: Secures the build plate
- ④ Build plate: Model building platform
- ⑤ Z-axis
- ⑥ Smart camera: Real-Time Monitoring & time-lapse photography
- ⑦ Resin level sensor: Detect the resin level
- ⑧ Resin vat: Stores the resin required for printing
- ⑨ USB interface: Transfers sliced files by USB flash drive
- ⑩ Resin vat fixing buckle: Secures the resin vat
- ⑪ 90° rotational touchscreen
- ⑫ Touchscreen: User-friendly Interface

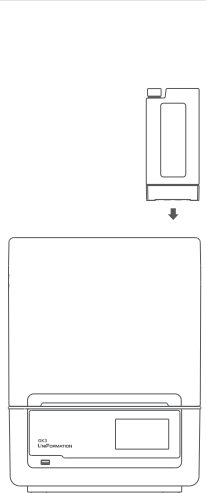
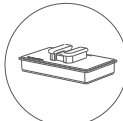
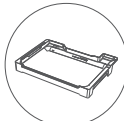

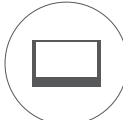
- ⑬ Resin cartridge installation port: Installs the automatic feeding resin cartridge
- ⑭ Activated carbon filter: Absorbs and filters the gas generated by printing
- ⑮ Cooling fan: Cools the printer
- ⑯ WiFi antenna port: Connects the WiFi Antenna
- ⑰ Ethernet Interface: Transfers sliced files by Ethernet.
- ⑱ Power socket: Connects the power cord

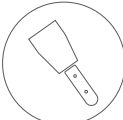
- ⑲ Build plate side hanging device: Hangs the build plate on the side to drain the resin
- ⑳ Resin vat liquid level detection: Connects the sensor on the resin vat detect the resin level
- ㉑ Resin vat detection switch: Checks whether the resin vat is installed
- ㉒ Power switch: Controls the power on and off of the machine
- ㉓ LCD screen: Displays the pattern to be printed on each layer
- ㉔ Automatic resin feed outlet: Resin flows into the resin vat

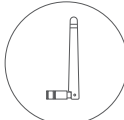
# 3. Packing Lists

 <p>GK3</p>				
	<p>Build Plate</p>	<p>Resin Vat</p>	<p>Power Cord</p>	<p>USB Flash Drive</p>
				
	<p>Screen Protector</p>	<p>NFEF Film</p>	<p>Metal Scraper</p>	<p>Leveling Paper</p>
				
<p>Tools</p>	<p>WiFi Antenna</p>	<p>Funnel</p>	<p>User Manual</p>	

## 4. Product Specifications

### 4.1 Printer parameters

Model Name	GK3
Maximum Print Volume	211 x 118 x H240 mm
Resin Vat Capacity	800 ml
Resin Cartridge Capacity	1200 ml
Product Dimensions	392 x 332 x 520 mm
Heating Power	120 W
Printing Power	130 W
Input Voltage	110/220 V
Slicing Software	UniFormation Slicer, Chitubox, Lychee Slicer
File Transfer Methods	USB Flash Drive, Ethernet
Supported File Formats	JXS, CTB

### 4.2 Official Resin Materials Compatibility

Standard Resin   ABS-Like Resin Water Washable Resin   Water Washable ABS-Like Resin	Black, White, Red Wax, Red Clay, Light Gray, Dark Gray, Transparent, Transparent Red, Transparent Blue, Transparent Green, Vanilla
Flexible Resin	Black, White, Transparent

### 4.3 Technical Parameters

Printing Technology	LCD (MSLA)
Light Source	405 nm COB + Fresnel Collimating Lens
Screen	16K 9.6-Inch LCD Mono Screen
Pixel Size	15120 x 6230
XY Resolution	14 x 19 μm
Screen Protector	Tempered Glass Film
Release Film	NEFP Film
Layer Thickness	0.01 mm - 0.15 mm
Resin	405 nm Resins
Exposure Time	1.5-2.5 s/layer (at 0.05 mm layer thickness)
Printing Tolerance	±0.1 mm (L ≤ 100 mm); ±0.1% x L (L > 100 mm)
Z-Axis	Widened Rail & Ball Screw

### 4.4 Main Highlights

Touch Screen	5-inch rotating capacitive touch screen (90° rotation)
Auto Heating Temperature	25°C / 30°C
Resin Feeding Method	Automatic Resin Feeding
Built-in Camera   APP Control	Yes
Preheat Function	Yes
Built-in Air Purifier	Yes
Built-in LED Light	Yes
Language Support	Chinese, Traditional Chinese, English, Japanese, German, French, Korean, Italian, Spanish, Portuguese, Russian, Turkish

Tips: The above parameters are UniFormation brand resin test results, for reference only.

## 5. Setup and Operational Check

### 5.1 Printer Setup

Unpack and take out the accessories. Place the machine in a flat, stable area. Remove the foam from the resin vat. Take out the activated carbon filter and build plate from the middle of the foam, and install the filter into the slot on the back of the machine.

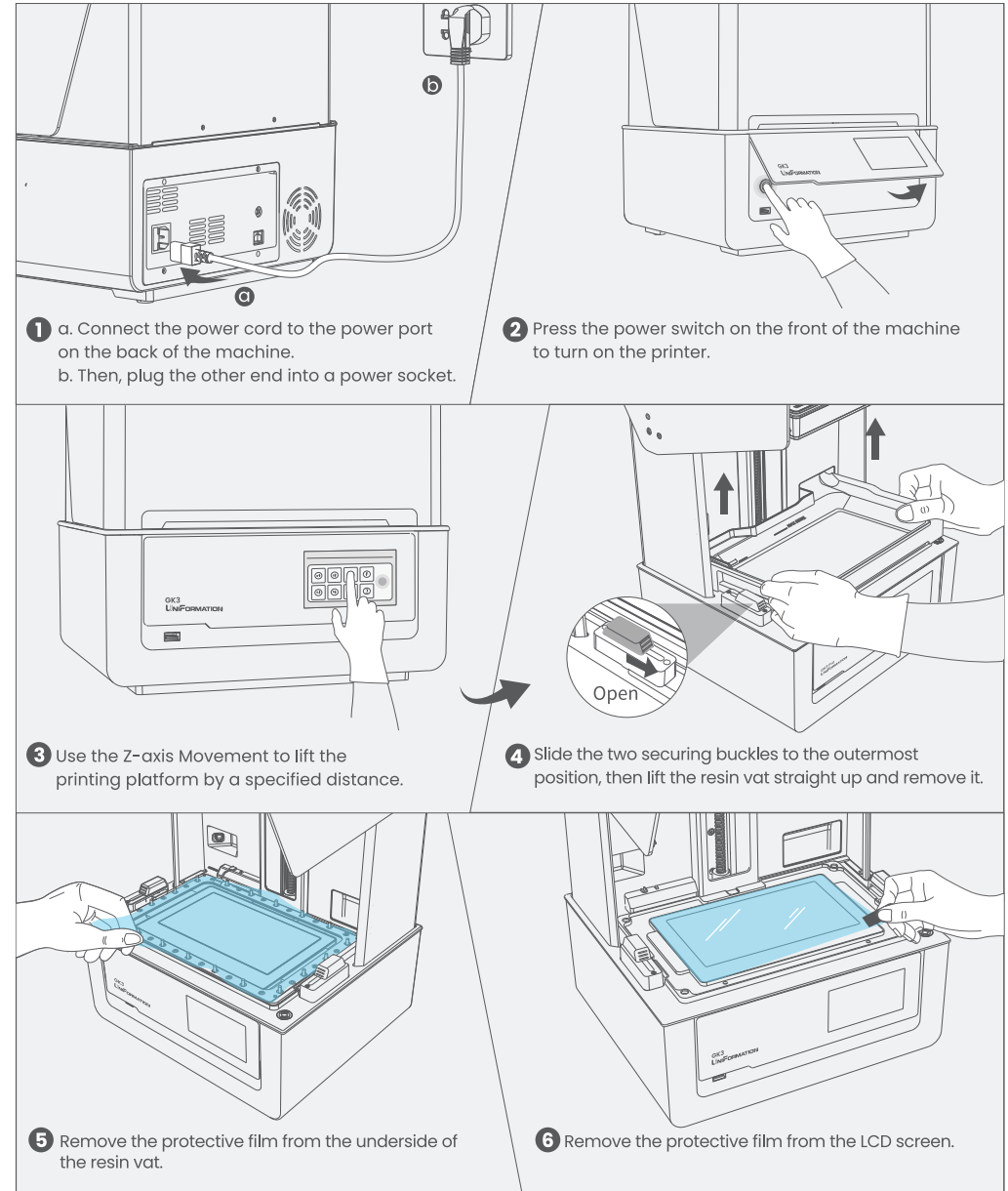

## 5.2 LCD Screen Exposure Test

Follow the steps shown in the picture below to enter the exposure test. If the screen displays the test pattern as shown in the figure, the display is functioning normally. If the screen is blank or displays an abnormal pattern, please contact a technician for assistance.

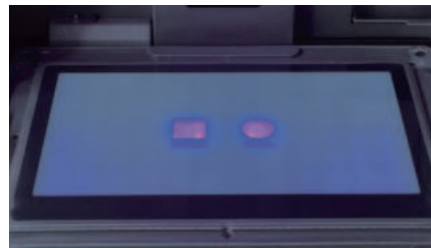
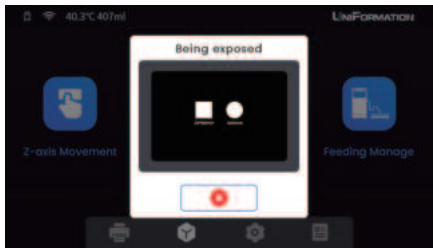
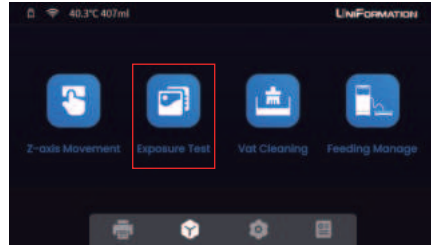
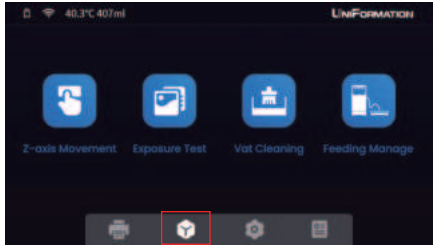

## 5.3 Leveling Test

The printing platform is leveled before leaving the factory, but vibrations during transportation may affect the leveling. Therefore, please check the leveling before starting the print to avoid potential printing failures.

1. Place the leveling paper on the LCD screen, then place the test strips on top of the leveling paper, as shown below:

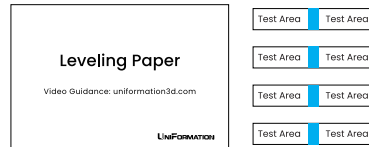

2. Click the "Y" icon to open the "Function Menu", then click the "Z-axis Movement" icon to access the "Z-axis Movement" interface.

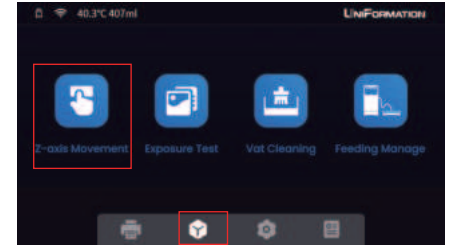

3. Click the "Z0" icon, and the printing platform will automatically lower to the zero position, pressing the test strips and leveling paper firmly.

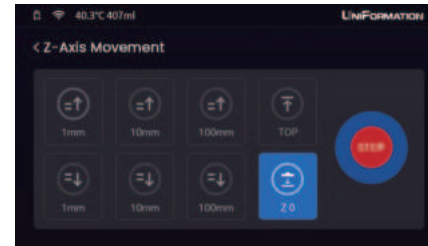

4. Pull out the test strips one by one. Under normal conditions, the test strips should be firmly in place and not easily pulled out. If the test strips can be pulled out easily, it may indicate a leveling issue with the printing platform. Please refer to the leveling video on the USB flash drive to re-level the printing platform, or contact technical support for assistance.

**Note:** The build plate can only be manually moved to the top after the "Z 0" operation .

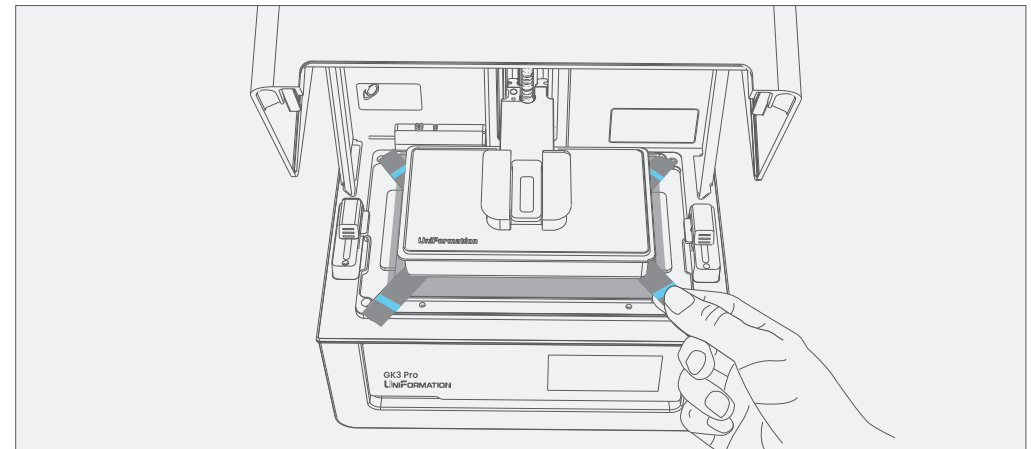

# 6. Operational Interface Introduction

## UI Introduction



Welcome Screen



Standby Mode

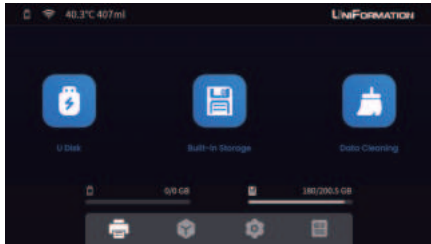

Print Menu

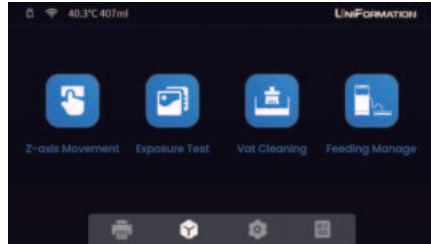

Function Menu

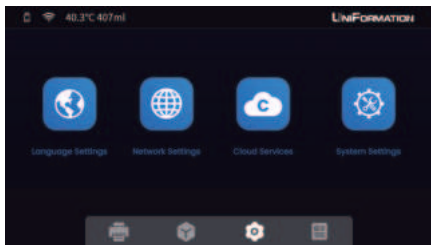

Settings Menu



Information Menu

## 6.1 Print Menu

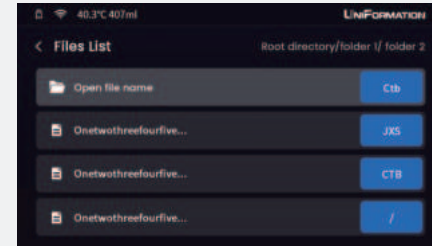

### USB Flash Drive

This screen displays the files stored on the connected USB flash drive.

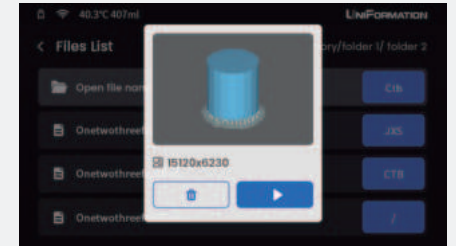

### Internal Storage

The printer will copy the sliced files from the USB flash drive to its internal storage and verify their integrity before starting the printing process.

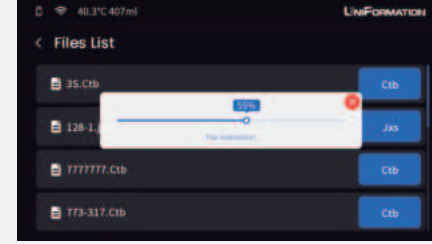

### File Validation

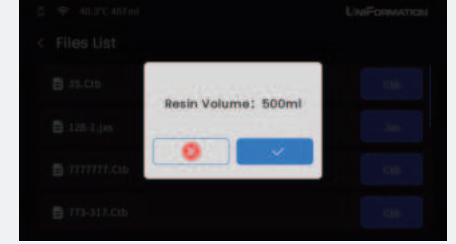

### Confirm Printing

Click the "√" button to start printing.

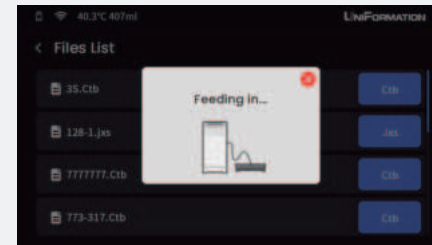

### Feeding in...

Resin feed is ready for printing.

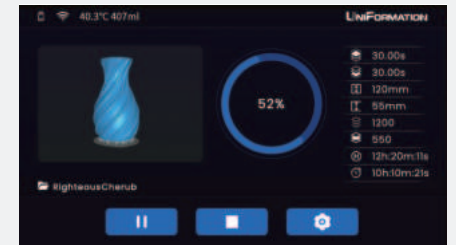

### View Printing Progress

On this screen, you can view the bottom layer exposure time, total print height, and more.

## 6.2 Function Menu

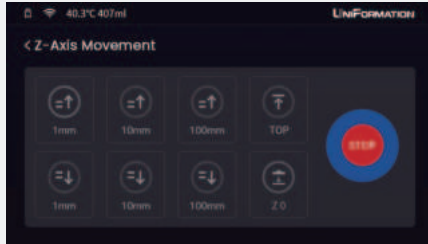

### Z-Axis Movement

Use the control interface to control the movement and zeroing of the build plate.

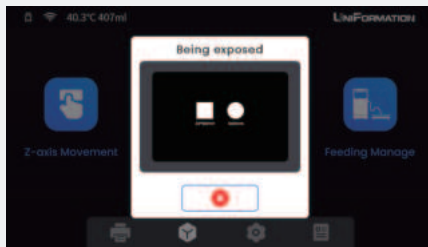

### Exposure Test

Use the control interface to test whether the screen exposure is normal.



### Resin Vat Cleaning

Use the control interface to perform a full-screen exposure and clean resin residue from the resin vat.

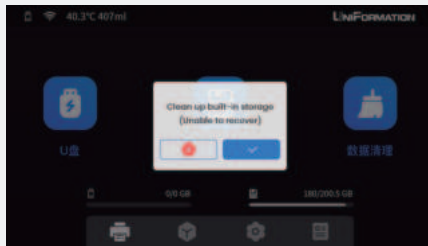

### Data Cleaning

Click the "✓" button to clean the built-in storage.

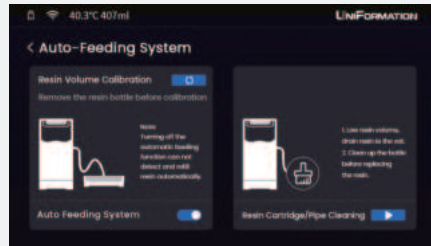

### Feeding Management

Automatic feeding system management and setup.

## 6.3 Settings Menu

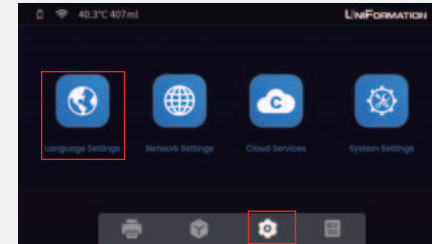

### Language Setting

Enter the "Settings Menu" and click the "Language Settings" icon to set the language.

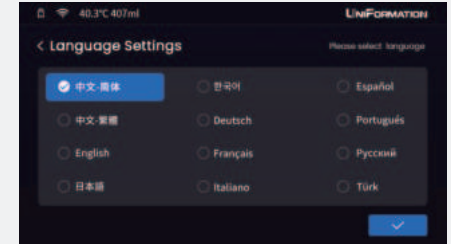

### Language Selection

Set the language in the control interface.

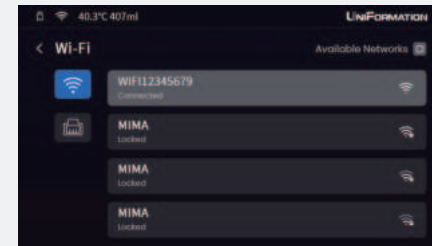

### Wi-Fi Settings

Set up the WiFi to connect to the network in the control interface.

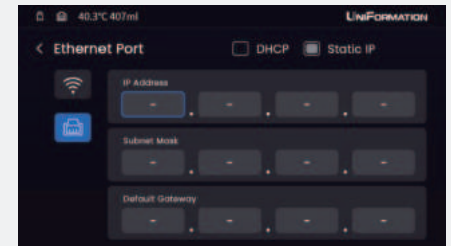

### Network Settings

Set up the Ethernet connection in the control interface.

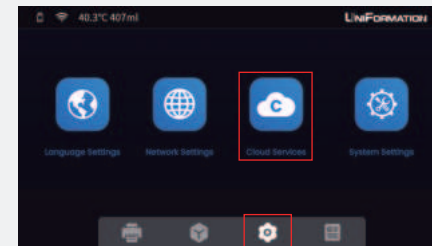

### Cloud Services

Enter the "Settings Menu" and click "Cloud Service" icon to download the UniFormation App.

(Note: UniFormation App is coming soon.)

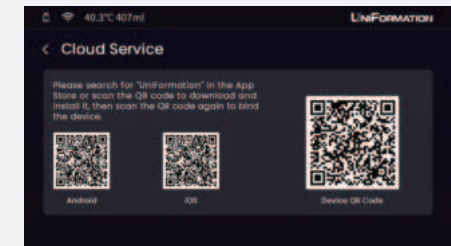

### Cloud Services

Scan the device's QR code to download the UniFormation app. Then, scan the QR code next to "Android" or "iOS" to bind the device in the interface.

## 6.4 Information Menu

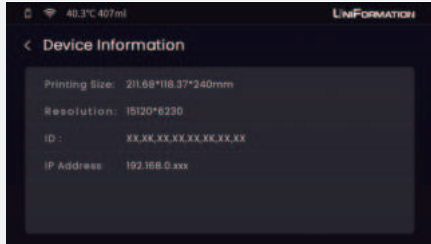

### Device Information

This interface displays the current system version and other system details.



### Usage Information

This interface displays the usage frequency of various consumables and the usage time of the activated carbon for easier maintenance.

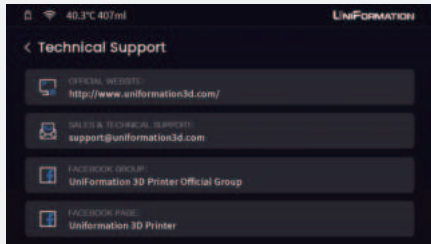

### Technical Support

This interface displays the technical support contact information.

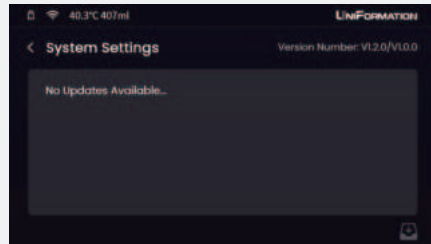

### System Update

The current firmware version is displayed in the upper right corner of the interface.

## 7. Function Overview

### 7.1 Preheat Function

In a low-temperature environment, turn on the printer's preheat function to maintain the resin temperature at 20°C, ensuring a safe start to the printing task within 3 hours. For safety, if the printing task is not started within 3 hours, the preheating function will automatically turn off.

1. Click the "⚙️" icon to open the "Settings Menu", then click the "System Settings" icon to access the "System Settings" interface

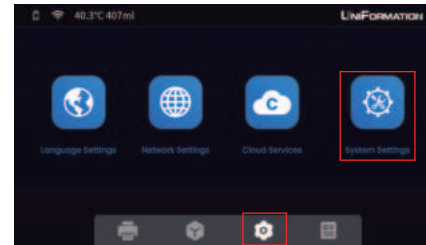

1. Settings Menu

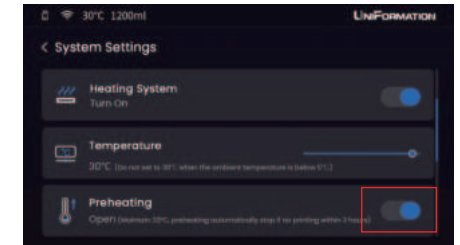

2. Turn on / Turn off Preheating

### 7.2 LED lighting

Auxiliary lighting helps facilitate observation of the machine.

1. Click the "⚙️" icon to open the "Settings Menu", then click the "System Settings" icon to access the "System Settings" interface.

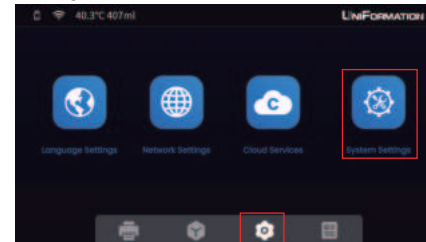

2. Scroll down in the "System Settings" interface to find the "LED Light" icon, which can be used to turn it on or off, as shown below:

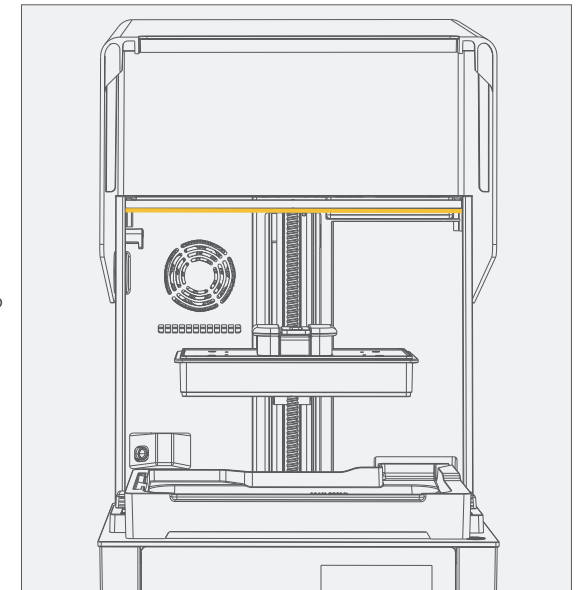
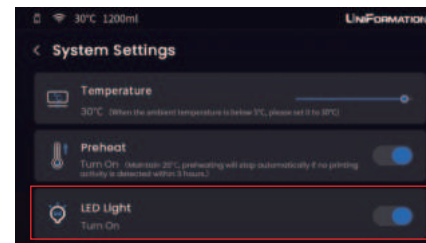

### 7.3 GK3 Automatic Heating System

This machine features an automatic heating function, which can be set to either 25°C or 30°C. If the heating function is disabled, the printer will begin printing immediately. When the heating function is enabled, the printer heats up to the set temperature before starting the print. The real-time temperature, as detected by the sensor, is displayed in the upper left corner of the touch screen.

**Note:** The machine features a heating function but does not maintain a constant temperature. If the ambient temperature is relatively high, the displayed temperature may exceed the ambient temperature due to heat generated by the UV lamp and machine operation. This is normal.

1. Click the "⚙️" icon to open the "Settings Menu", then click the "System Settings" icon to access the "System Settings" interface.

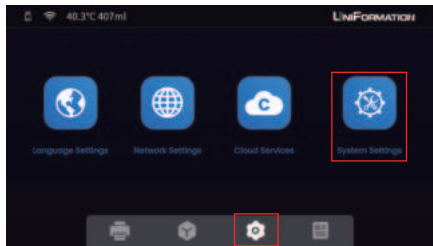

1. Settings Menu

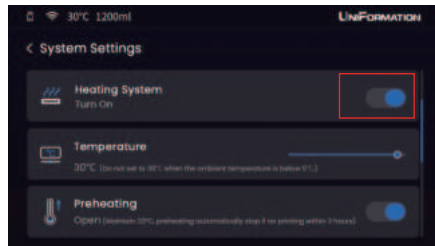

2. Turn On / Turn Off Heating Function

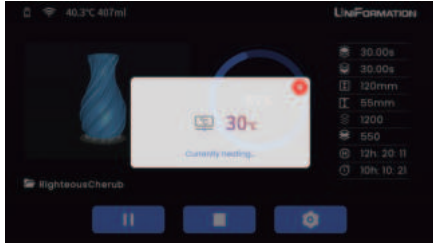

3. Start heating.

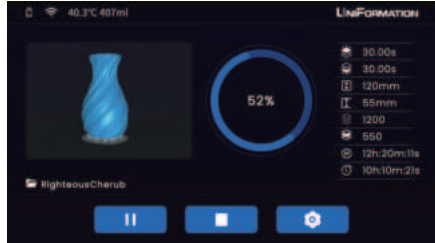

4. Once the desired temperature is reached, printing will begin automatically.

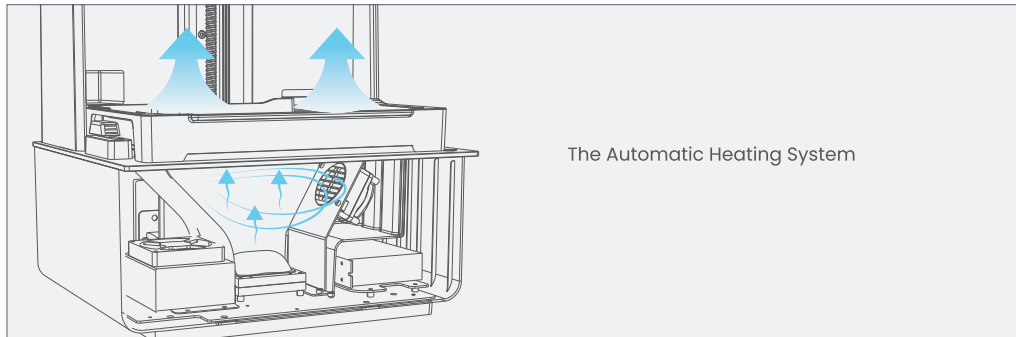

The Automatic Heating System

### 7.4 Automatic Feeding System Introduction

#### 7.4.1 Function On and Off

Turn on the auto-feeding system, it will detect the resin level in the resin vat before starting the print.

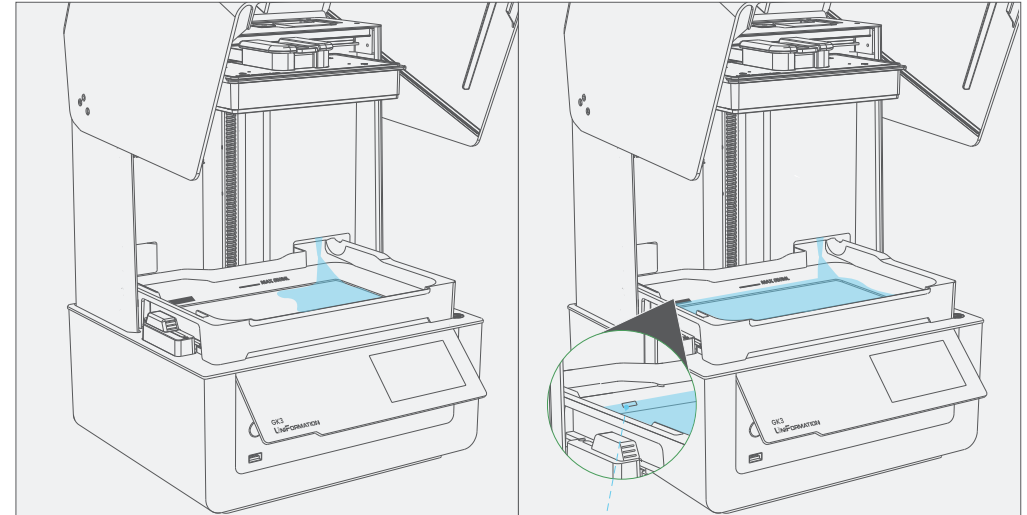

Resin Level Sensor

- 1 When the resin level in the resin vat does not reach the sensor's position, the system will automatically extract resin from the resin cartridge and add it to the resin vat.
- 2 Once the resin level in the vat reaches the sensor's position, the automatic feeding system will stop working.

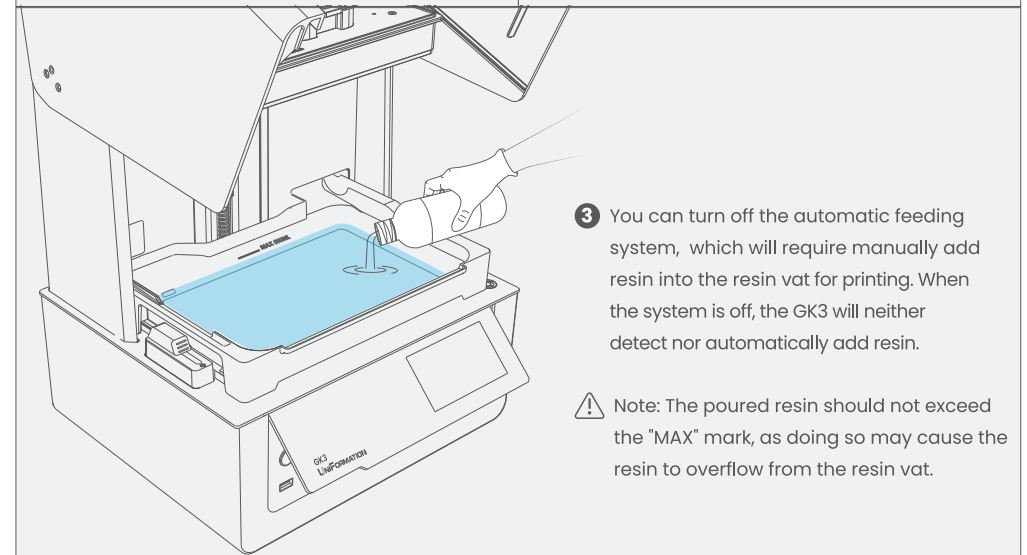

- 3 You can turn off the automatic feeding system, which will require manually add resin into the resin vat for printing. When the system is off, the GK3 will neither detect nor automatically add resin.

**Note:** The poured resin should not exceed the "MAX" mark, as doing so may cause the resin to overflow from the resin vat.



#### 7.4.2 Cartridge Calibration Function:

If the resin capacity display shows a significant deviation, use this function to recalibrate the weight sensor for more accurate detection of the resin weight in the cartridge.

#### 7.4.3 Cartridge Cleaning Function:

If only a small amount of resin remains in the cartridge, you can use the cartridge cleaning function to transfer the remaining resin into the resin vat.

#### 7.4.4 Tube Cleaning Function:

When replacing resin for printing and to avoid inconsistent colors, use this function to flush the remaining resin in the tube with new resin from the cartridge.

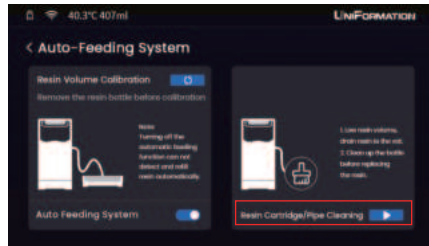
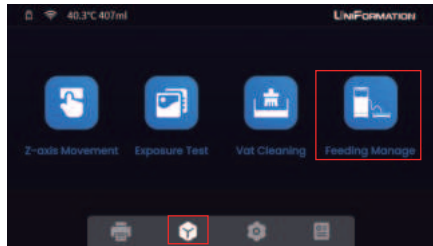

## 7.5 Network Connection

### 7.5.1 WiFi Connection

WiFi Setup (Requires WiFi Antenna)

Setup: Plug the compatible WiFi antenna into the port on the back of the machine.

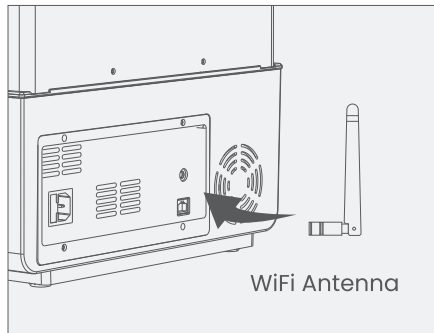

1. Go to the Settings Menu and click on the Network Settings icon to connect to a Wi-Fi network.

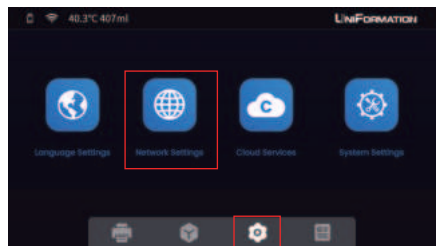

2. Select and connect to a Wi-Fi network.

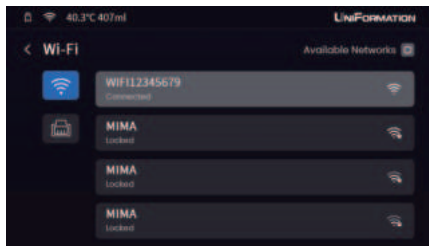

### 7.5.2 Ethernet Connection

1. Plug the cable into the Ethernet port on the back of the machine. Enter the "Network Settings" menu, select the wired port connection on the left, and choose the "DHCP" or "Static IP" option according to your needs.

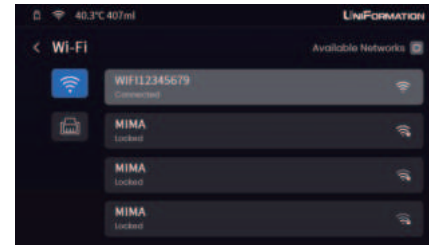

2. If you choose the "DHCP" option, the machine will let the router of your network automatically assign an IP address, you should not need to fill in the IP address, subnet mask and default gateway. If you choose "Static IP" then you probably already know what you're doing, please fill in the corresponding IP address, subnet mask and default gateway according to your LAN.

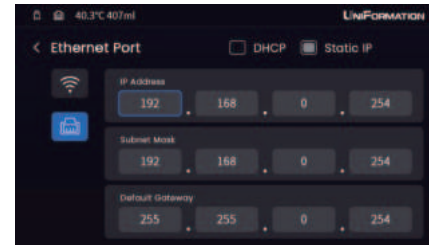

## 7.6 Transfer Sliced Files

Use the ChituManager 3D printer management software to remotely transfer sliced files, helping you save time and improve efficiency.

# 8. First Printing Instructions

## 8.1 Overview of Slicing Software

3D printers read sliced files and print three-dimensional objects layer by layer. To print, you first need to convert 3D model files (STL/OBJ) into sliced files that the printer can read. This process, known as "slicing", involves dividing the 3D model into multiple layers. The software used to convert 3D model files into sliced files is called slicing software.

GK3 can only recognize files in XJS and CTB formats and cannot directly print STL or OBJ files. You need to use UniFormation Slicer, Chitobox Slicer, or Lychee Slicer to slice STL or OBJ files into XJS or CTB format sliced files, then transfer them to the printer via a USB flash drive or network for printing.

You can use the slicing software to adjust the model's placement angle and size, create shells and holes, add supports, set exposure parameters, and export sliced files with the (JXS/CTB) suffix.

**Note:** For specific operation guides for the slicing software, please refer to the files on the USB drive. For Chitubox and Lychee slicing software, consult the operation documents or videos on their official websites. The sliced file format from UniFormation Slicer has a JXS suffix, while the sliced files from Chitubox and Lychee have a CTB suffix.

## 8.2 Printing Preparation

Before printing, please carefully check whether there is any resin residue on the screen protector and ensure that the release film is free from damage or severe creases. If any issues are found, clean the screen protector or replace the release film and protector to avoid damage to the machine.

### 8.2.1 Installing the Resin Cartridge

1. Wear a mask and gloves (as resin should not come into direct contact with the skin). Shake the resin cartridge for 1 minute, then insert it into the automatic resin feeding cartridge installation port.

2. When installing or replacing the resin cartridge, be sure to open the air inlet by pressing the outer edge of the cartridge lid. This allows air circulation and ensures that the machine's automatic resin feeding system functions properly before and during printing.

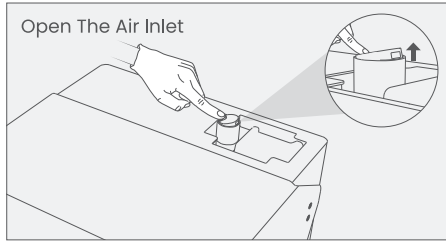
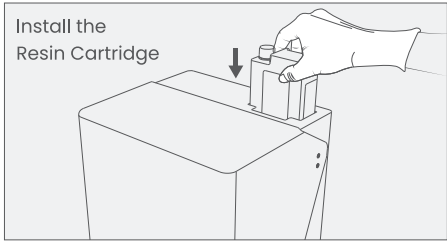

3. At this point, the upper left corner of the screen displays the amount of resin in the inserted resin cartridge.

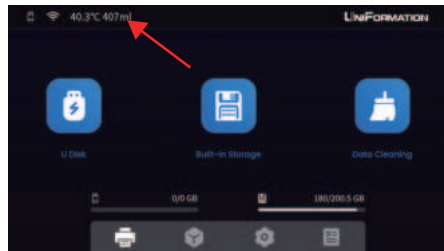

## 8.3 Model Printing

- Check to ensure that the printing platform and resin vat are clean, dry, and free of impurities.
- Close the flip cover and insert the USB flash drive containing the sliced files into the printer, or select the sliced files transferred via the network from the built-in storage.
- Click the file name, then click the "Start" icon (a triangle) in the pop-up model preview interface to continue. A resin consumption window for the model to be printed will then appear.

- After clicking "Confirm", the system will automatically copy the sliced files to the printer's built-in storage.
- The printer checks the resin level. If it's below the sensor position and the automatic feeding function is enabled, the printer will automatically add resin until the level in the resin vat reaches the sensor.
- The printer will begin heating the resin to the set temperature. Once the temperature is reached, the printer will start printing immediately.

**Note:** Printing involves many variables, so the time displayed on the touch screen is an estimate based on when the printer begins reading the sliced file. The actual printing time may vary.

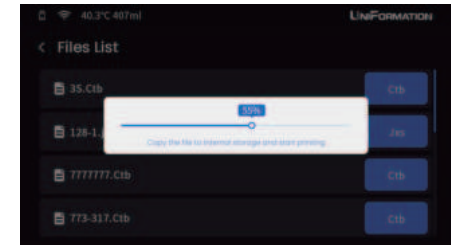
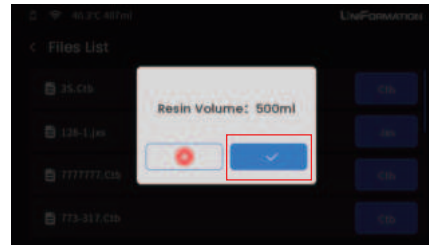
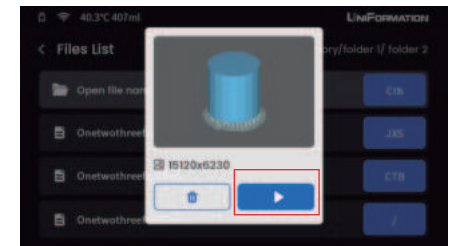
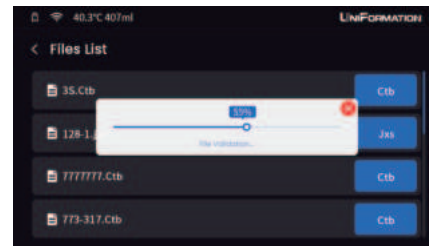
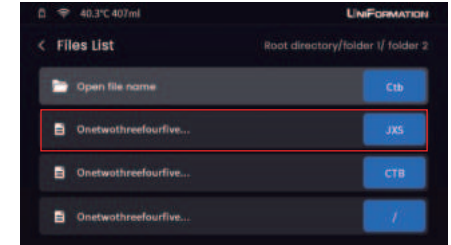
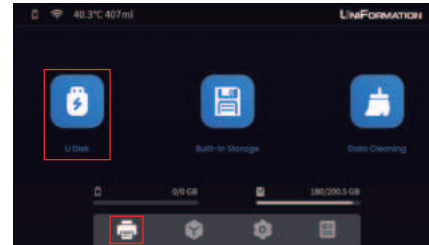

The printer will automatically copy the file to be printed to the built-in storage and then start printing. After printing begins, you can unplug the USB drive.

## 8.4 UniFormation App & Camera Overview

Users will be able to control the camera through both the app and the slicing software. This will allow for real-time monitoring, time-lapse photography, one-click printing, and remote control of the printing process.

The App is coming soon



UniFormation APP



Video display

## 8.5 Post-print processing

### 8.5.1 Drain the Resin

1. After printing is complete, unlock the platform securing buckles and remove the build plate.

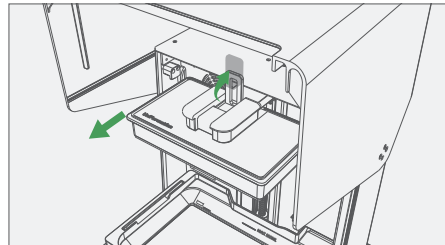
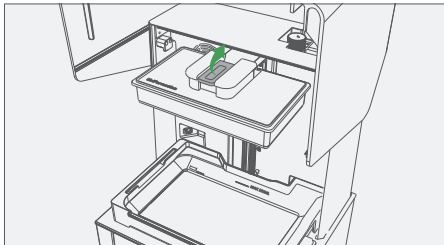

2. Place the build plate upright on the side hanging devices of the printer to allow the resin to drain back into the resin vat.

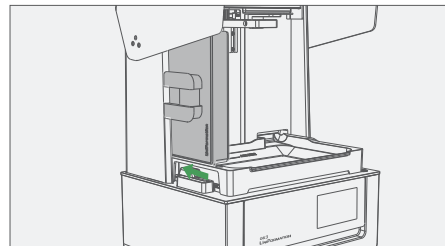
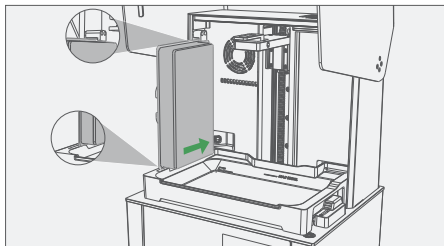

### 8.5.2 Clean and Re-Cure the Model

After draining the resin, you can either clean the model first and then remove the supports, or remove the supports first and then clean the model:

- If the supports are complex, first use a spatula to gently scrape the model off. Then, clean the model with 95% or higher IPA (Isopropyl Alcohol) or another suitable detergent. After cleaning, carefully remove the supports.
- If the supports on the model are easy to remove, first use a spatula to gently scrape the model off, then remove the supports, and then place the model in the washing machine for cleaning.

Ensure that any alcohol remaining on the surface or inside the model is completely dried—either by blowing it dry or allowing it to air dry. Then, cure the model using a UV curing machine or place it in direct sunlight for secondary curing to achieve optimal hardness.

 Note: If the model is not cleaned thoroughly, the surface may become sticky or develop white marks after curing.

### 8.5.3 Printing Failure Processing

1. In the case of incomplete curing or a printing failure, cured resin residues may form in the resin vat. Use a funnel to filter out these residues, then store the filtered resin in the corresponding cartridge. If this step is skipped, the residues may cause printing failures or damage the release film and screen during subsequent prints.

2. Cleaning the Resin Remaining on the Release Film: Use the resin vat cleaning function to cure the bottom layer of resin, then peel off the entire layer of cured resin. This process helps protect the release film. Note: Do not scrape or pry the release film with sharp objects, as this may damage the resin vat.

3. The remaining resin on the printing platform and in the resin vat can be wiped clean directly with a paper towel.

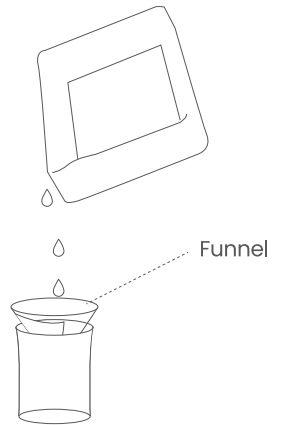

### 8.5.4 Troubleshooting Printing Issues

#### a. Take Photos

If a printing failure occurs, take clear photos or videos of the failed model on the printing platform. This can help identify the issue more effectively.

#### b. Clean the Resin Vat

Next, clean the printing platform and the resin vat thoroughly.

#### c. Check Screen Exposure

After cleaning, use the "Exposure Test" and "Vat Cleaning" functions to check if the screen exposure is normal.

#### d. Check Leveling

If the screen exposure is normal, check if the printing platform is leveled correctly.

#### e. Check Slicing Settings

After confirming that there are no hardware issues, check if the slicing settings are correct. If you notice any anomalies, please contact customer service immediately or email technical support for assistance.

## 9. FAQ and Maintenance

### 9.1 Release Film Rupture

This is usually caused by resin residue in the resin vat during printing, or by cured resin falling into the vat when the print fails. When the print platform descends, it can compress the cured resin residue, causing the release film to be punctured. Before printing, always check for any foreign matter in the resin vat. You can use a soft scraper to stir and observe.

If resin leaks due to a ruptured release film, clean the leaked resin with alcohol, then refer to the tutorial video on the USB flash drive to replace the release film with a new one.

## 9.2 Cured Resin on the Screen Protector

If resin accidentally drips onto the surface of the screen protector, or if the damaged release film causes resin to leak and cure on the protector, you can use a plastic scraper or your fingernail to remove the cured resin, provided the affected area is relatively small. However, if a large area of resin has cured on the protector, the screen protector will need to be replaced. Please refer to the tutorial video on the USB flash drive for instructions on how to install a new screen protector.

## 9.3 Model Not Sticking to the Printing Platform

If the model fails to adhere to the printing platform during printing and is fully cured on the release film, or if one side of the model sticks to the printing platform while the rest cures on the release film, this often indicates a leveling issue. Please refer to the tutorial video on leveling on the USB flash drive to re-level the printing platform and test with a leveling model to confirm. Alternatively, check for the following two possible causes of the model detaching from the printing platform:

- a. The exposure time for the bottom layer may be insufficient; please increase the exposure time.
- b. The contact area between the bottom surface of the model and the printing platform is too small; a bottom valve may need to be added.

## 9.4 Model Layer Separation and Cracking

- a. The printing platform or print components are loose, causing the model to fracture.
- b. Resin residue is present in the resin vat. Filter out the residue and print again.
- c. The hollow model is not perforated, which leads to vacuum adhesion issues. The model needs to be perforated to balance the air pressure.
- d. The lifting speed is too fast.
- e. The release film may loosen after prolonged use and needs to be replaced.
- f. The printer shakes during printing.

## 9.5 Model Has Layer Lines and Deformation

- a. Check if there are insufficient supports. If the supports are inadequate, the model may wobble during printing, causing print issues.
- b. Reduce the lifting speed.
- c. Check if the release film and screen protector are sticking together.

## 9.6 Flocculent Particles Similar to Kelp in the Resin Vat

- a. Check for light leakage or any external light source affecting the screen.
- b. If the particles are caused by overexposure, reduce both the bottom exposure time and the normal exposure time.

## 9.7 Machine Maintenance

- a. The usage time of the screen, light source, activated carbon filter, and the number of layers used on the release film can be checked in the Usage Information menu to determine if they need to be replaced.
- b. If the printer is not used for more than 48 hours, pour the resin back into the resin storage cartridge. (Note: Any residue should be filtered out.)
- c. After printing, promptly clean the printing platform and resin vat. First, wipe them with paper towels, then clean with alcohol to prevent residual resin from solidifying due to exposure to strong light.
- d. If the machine is accidentally stained with resin, clean it with alcohol.
- e. When switching to a different type or color of resin, be sure to clean out the original resin first.

Thank You for Choosing UniFormation Products!

We offer a one-year warranty (excluding consumable parts). If you encounter any issues, please contact our online customer service for assistance. Our professional technical support team is always available to help.

Additionally, to foster communication and exchange among 3D printing enthusiasts and to share the latest advancements in 3D printing technology, we have established relevant communities and sharing platforms. We look forward to your participation and contributions!



Facebook



Instagram



Tiktok



Youtube

For warranty service or support, please contact the technical support team:

Website: [www.uniformation3d.com](http://www.uniformation3d.com)