

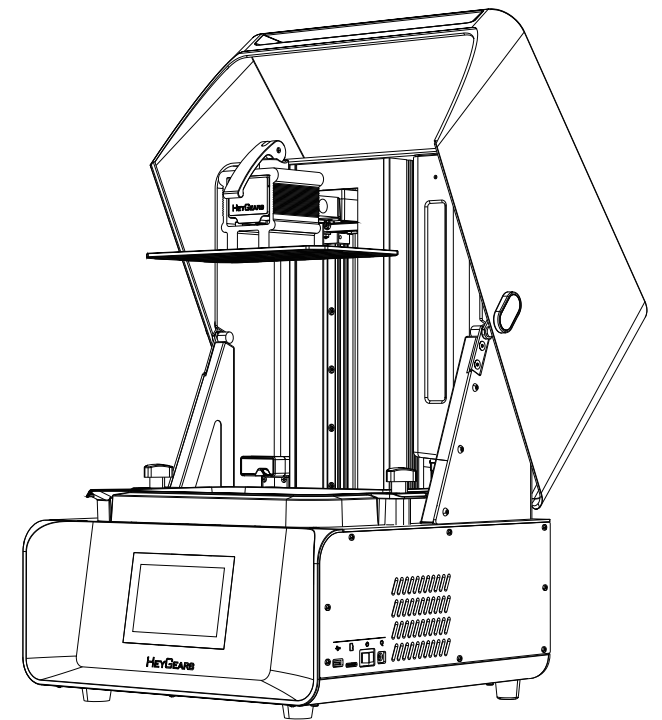

Reflex RS

Professional-Grade Printer



🌐 [heygears.com](https://www.heygears.com)

✉ info@heygears.com

☎ Tel: +1 (318) 353-4295 (Global) / +1 (949) 418-9418 (USA) / +44 148-396-8549 (EU)

📍 USA-17931 Sky Park Circle, Suite E, Irvine, CA, 92614
CHN-Block B2, 501, 601, Enterprise Accelerator, Kaifa District, Guangzhou City

Follow us @HeyGears



Please make sure to read and understand this Quick Start before unpacking and installing.

Thank you for choosing HeyGears. For your own safety, please operate as per this Quick Start. If you fail to comply with the instructions in this manual, HeyGears will not be liable for the consequential damages unless required by all applicable laws and regulations.

Please keep this operation manual properly for future reference. The pictures are for reference only and the products are subject to the actual product.

1 Items & Parameters

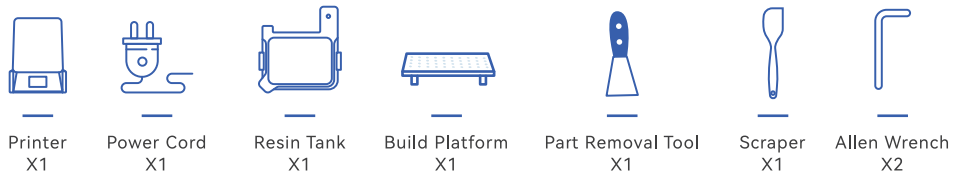

Name	UltraCraft Rapid Production System	Input	24V 7.5 A
Model	UltraCraft Reflex RS	Weight	20 kg
Dimensions	380*360*584 mm	Power	180 W

2 Components

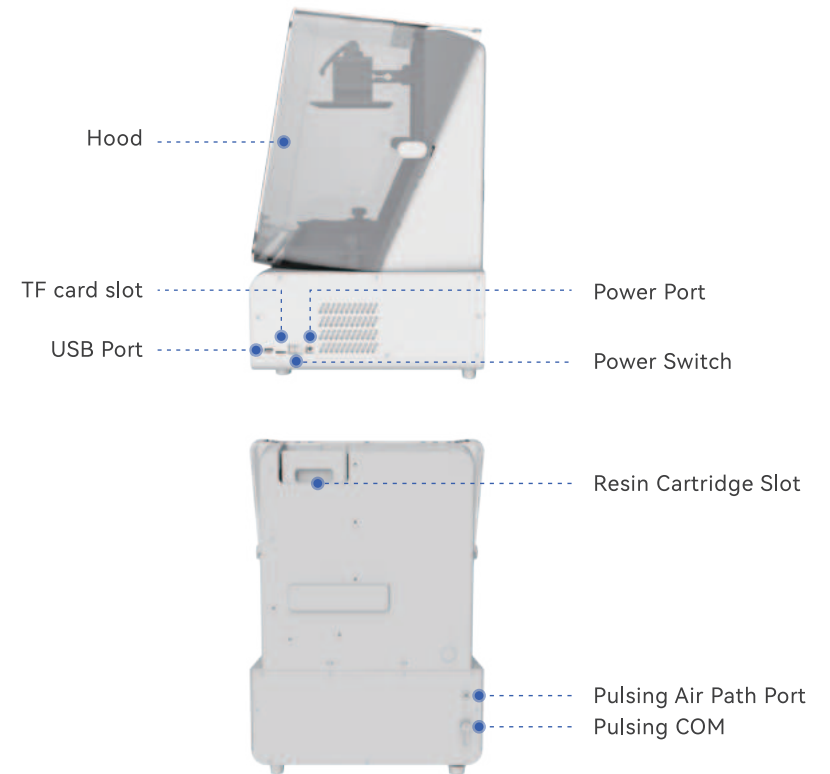

3 Installation Requirements

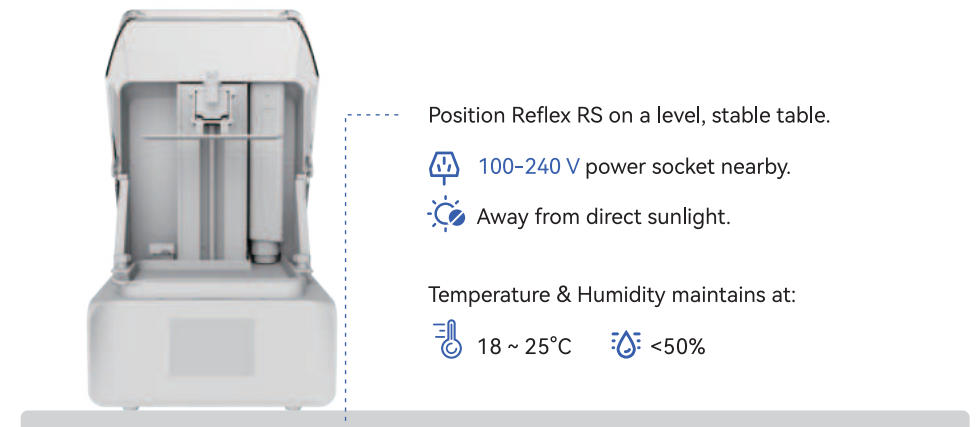

4 Operation Steps

STEP 1

Place the printer on a level, stable table, and check its appearance to confirm if it's in good condition. Lift the hood to its highest position. Plug the provided power cord in the power port, connect it to power supply and turn on the power switch. The touch screen lights up, indicating the power is successfully connected.

***Please DO NOT remove the filler in the cabinet before connecting to power.**

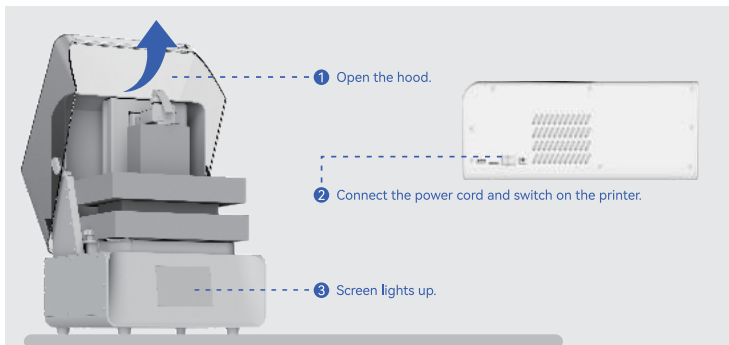

STEP 2

Wait until the printer's main axle rises to top, and then remove the filler in the cabinet. Follow the onboard guide on the touch screen to finish installation.

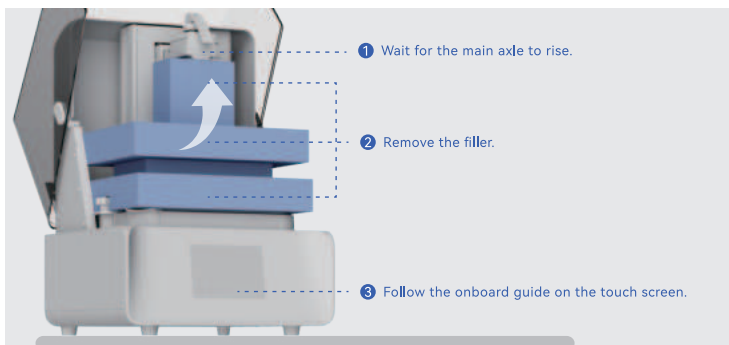

STEP 3

Afterward, please download Blueprint Studio from <https://www.heygears.com/SAP/Blueprint>, follow its onboard guide for print preparation (pre-processing) and send the finished printable slice file to your Reflex RS. Then print it on your printer by operating on the printer's touch screen. Videos of guides are available in Help Center on Blueprint Studio.

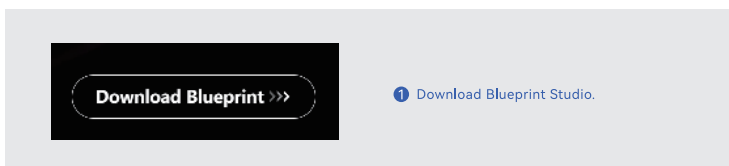

STEP 4

When printing is done, open the hood, unlock and take out the build platform. Then follow the instructions for post-processing like washing, part removing, support removing and post-curing, etc..

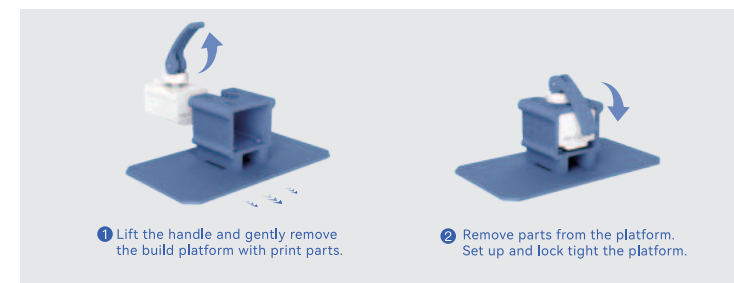

5 Release Film Replacement

Images below are examples of the resin tank and the spare release film.

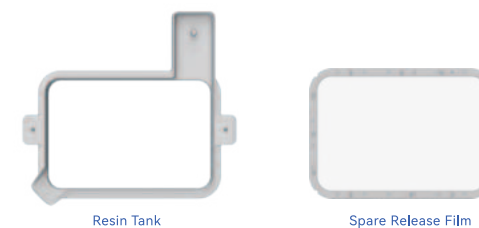

STEP 1

Remove the resin cartridge. Then unscrew (counterclockwise) the bolts on both sides of the resin tank, and lift the tank to remove it. If there's resin or any residues in it, make sure to clean it well, and only then can you remove its release film.

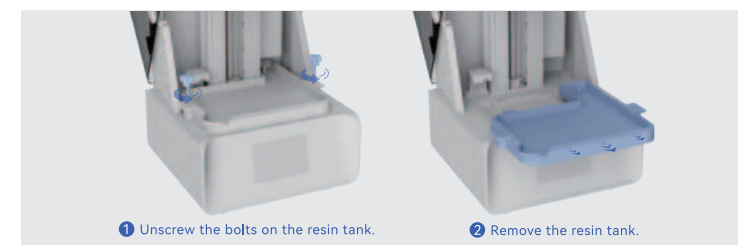

STEP 2

Remove all the screws on the release film from the bottom of the resin tank with the provided wrench. Then remove the film.

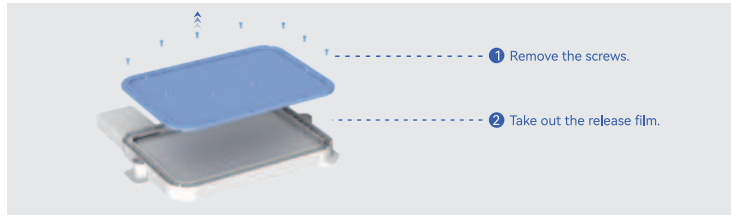

STEP 3

Set up a new release film back onto the tank. Screw back tight the screws on the diagonals and then other screws. When the film is installed well in place, its frame should be level with the resin tank frame. Mount back the tank onto the printer.

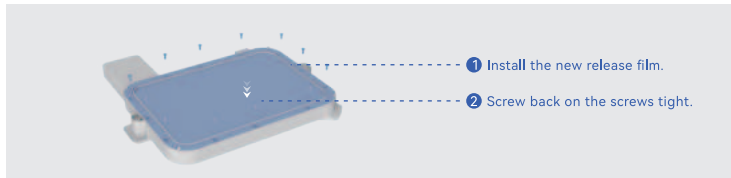

6 Cautions



01

Always remember to close the hood in time whenever you open it for operation. Do NOT open the hood during printing, or print precision might be affected due to dusts, vibration or so.



02

Plastic components such as hood and touch screen are not resistant to long-time exposure to resin or alcohol. Please wipe them clean if there's resin or alcohol on them.



03

Please place the printer and resin cartridges properly, away from any light, dusts, or direct sunlight, or printing quality or precision might be affected.



04

Keep the device away from fire.



05

When you use your Reflex RS, please pay attention to whether there's any resin on the projection screen. If any, it indicates that the resin tank's release film might have been broken and is leaking resin, which might cause damages to the printer. In this case, clean off the resin as soon as possible, enter the printer's settings and project a pure white image to check the printer's condition. If the printer does not work properly, please contact HeyGears Support.



CAUTION UV emitted from this product. Eye or skin irritation may result from exposure. Use appropriate shielding.

Note: Reflex RS uses 405 light source curing, please do not look directly at the UV light when printing; Wear protective glasses and gloves when necessary.

BY AN INCORRECT

- CAUTION RISK OF EXPLOSION IF BATTERY IS REPLACED TYPE.
- DISPOSE OF USED BATTERIES ACCORDING TO THE INSTRUCTIONS.
- Do not ingest battery, Chemical Burn Hazard. This product contains a button cell battery. If the button cell battery is swallowed, it can cause severe internal burns in just 2 hours and can lead to death.
- Keep it away from children.
- If you think batteries might have been swallowed or placed inside any part of the body, seek immediate medical attention.
- The product shall require connection of the equipment protective earthing conductor to the installation protective earthing conductor (for example, by means of a power cord connected to a socket-outlet with earthing connection).
- When the plug on the power supply cord is used as the disconnect device, the socket-outlet shall be easily accessible.
- This equipment is not suitable for use in locations where children are likely to be present.

