

# Table of Contents

<b>1. Introduction</b>	5
Step 1 - General information	6
Step 2 - Tools in the package	6
Step 3 - Labels guide	7
Step 4 - Cheatsheet	7
Step 5 - Front, left, right and rear side	8
Step 6 - Transportation foam pads	8
Step 7 - Manipulating with the printer	9
Step 8 - Silicone sock	9
Step 9 - CAUTION: Lubricant Handling	10
Step 10 - View high resolution images	10
Step 11 - We are here for you!	11
Step 12 - Reward yourself	12
<b>2. Base &amp; Side frame assembly</b>	13
Step 1 - Tools necessary for the next steps	14
Step 2 - Base frame parts preparation	14
Step 3 - Extrusion alignment	15
Step 4 - Right rear extrusion assembly	15
Step 5 - Securing the right rear extrusion	16
Step 6 - Left rear extrusion assembly	16
Step 7 - Z-Axis assembly clarification	17
Step 8 - Z-Axis fixed assembly	17
Step 9 - Securing the Z-Axis fixed	18
Step 10 - Z-Axis rotary assembly	18
Step 11 - Securing the Z-Axis rotary	19
Step 12 - Torque indicator: parts preparation	19
Step 13 - Assembling the Torque indicator	20
Step 14 - Final tightening with torque indicator	20
Step 15 - Haribo time!	21
Step 16 - xLCD: parts preparation	21
Step 17 - xLCD cable covers: parts preparation	22
Step 18 - Extrusion covers: parts preparation	22
Step 19 - Mounting the xLCD	23
Step 20 - Aligning the xLCD	23
Step 21 - xLCD assembly versions	24
Step 22 - Version A: Installing the xLCD PE cable	24
Step 23 - Version B: Installing the xLCD PE cable	25
Step 24 - xLCD PE cable management	25
Step 25 - xLCD cable routing	26
Step 26 - Routing the cables	26
Step 27 - Routing the cables	27
Step 28 - Routing the cables	27
Step 29 - Horizontal cable inserting	28
Step 30 - Corner frame cover	28
Step 31 - Inserting Z-motor-cable-bottom-cover	29
Step 32 - Preparing the cables for rear cover	29
Step 33 - Inserting the second motor cable	30
Step 34 - Inserting Z-motor-cable-bottom-cover	30
Step 35 - Haribo time!	31
Step 36 - Well done!	31

<b>3. CoreXY &amp; Back assembly</b>	32
Step 1 - Tools necessary for this chapter	33
Step 2 - Torque indicator disassembly	33
Step 3 - Installing the CoreXY assembly: parts preparation	34
Step 4 - How to insert the M3nEs nuts	34
Step 5 - CoreXY assembly	34
Step 6 - Installing the CoreXY assembly	35
Step 7 - Installing the CoreXY assembly	35
Step 8 - Securing the CoreXY	36
Step 9 - Manipulating with the printer	36
Step 10 - Torque indicator: parts preparation	37
Step 11 - Assembling the Torque indicator	37
Step 12 - Securing the CoreXY	38
Step 13 - Haribo time!	38
Step 14 - Securing the left linear rail	39
Step 15 - Securing the right linear rail	39
Step 16 - Earthing-connectors: parts preparation	40
Step 17 - Inserting the M3nEs nuts into extrusions	40
Step 18 - Grounding the Frame	41
Step 19 - Grounding the sides	41
Step 20 - Grounding the rear side	42
Step 21 - Cover-clips: parts preparation	42
Step 22 - Attaching the cover-clips	43
Step 23 - Attaching the cover-clips	43
Step 24 - XL rear panel: parts preparation	44
Step 25 - Removing the electronics casing	44
Step 26 - Attaching the XL rear panel	45
Step 27 - Attaching the XL rear panel	45
Step 28 - Installing the XL rear panel	46
Step 29 - Installing the XL rear panel	46
Step 30 - Haribo time!	47
Step 31 - Rear left: cable management	47
Step 32 - Rear left: PE cable	48
Step 33 - Rear left: connecting the cables	48
Step 34 - Rear left: securing the cables	49
Step 35 - Rear right: cable management	49
Step 36 - Rear right: connecting the cables	50
Step 37 - The Wi-fi antenna versions	50
Step 38 - Version A: Rear right: connecting Wi-Fi Antenna	51
Step 39 - Installing the frame grounding	51
Step 40 - Rear right: securing the cables	52
Step 41 - Overview of electronics wiring	52
Step 42 - Rear electronics covers preparation	53
Step 43 - Rear electronics cover	53
Step 44 - Installing XL buddy box cover	54
Step 45 - Installing the extrusion covers: parts preparation	54
Step 46 - Installing front extrusion covers	55
Step 47 - Installing rear extrusion covers	55
Step 48 - Haribo time!	56
Step 49 - Good job!	56
<b>4. Heatbed &amp; Side panels assembly</b>	57
Step 1 - Tools necessary for this chapter	58
Step 2 - Side panels preparation	58
Step 3 - Left side panel assembly (part 1)	59

Step 4 - Left side panel assembly (part 2) .....	59
Step 5 - Right side panel assembly .....	60
Step 6 - Haribo time! .....	60
Step 7 - Heatbed assembly preparation .....	61
Step 8 - Heatbed terminals preparation .....	61
Step 9 - Connecting the Heatbed cables .....	62
Step 10 - Assembling the Heatbed .....	62
Step 11 - Removing linear rail stoppers .....	63
Step 12 - Installing the Heatbed .....	63
Step 13 - Attaching the Heatbed .....	64
Step 14 - Preparing the Z-Axis bearing housing .....	64
Step 15 - Installing the Z-Axis bearing housing .....	65
Step 16 - Preparing the Heatbed screws .....	65
Step 17 - Fixing the Z-axis side parts in place .....	66
Step 18 - Fixing the heatbed cables .....	66
Step 19 - Haribo time! .....	67
Step 20 - Good job! .....	67
<b>5. Extruder &amp; accessories assembly .....</b>	<b>68</b>
Step 1 - Tools necessary for this chapter .....	69
Step 2 - Preparing the X-carriage .....	70
Step 3 - Installing the ToolChanger: parts preparation .....	70
Step 4 - Preparing the ToolChanger .....	71
Step 5 - Installing the ToolChanger .....	71
Step 6 - Covering the X-carriage .....	72
Step 7 - Preparing the Filament sensor .....	72
Step 8 - Attaching the filament sensor .....	73
Step 9 - Nextruder assembly: parts preparation .....	73
Step 10 - Nextruder cable bundle assembly .....	74
Step 11 - Nextruder cable bundle assembly .....	74
Step 12 - Nextruder dock preparing .....	75
Step 13 - Guiding the first Nextruder cable .....	75
Step 14 - Attaching the first Nextruder dock .....	76
Step 15 - Dock inspection .....	76
Step 16 - Dock inspection: video .....	77
Step 17 - Nozzle seal: parts preparation .....	77
Step 18 - Assembling the Nozzle seal .....	78
Step 19 - Nextruder nozzle seal .....	78
Step 20 - First nextruder docking .....	79
Step 21 - Guiding the second Nextruder cable .....	79
Step 22 - Dock inspection .....	80
Step 23 - Dock inspection: video .....	80
Step 24 - Nextruder nozzle seal .....	81
Step 25 - Second Nextruder docking .....	81
Step 26 - Guiding the extruder PTFE tube .....	82
Step 27 - Wi-fi antenna holder versions .....	82
Step 28 - Version A: Connecting the Nextruder cables .....	83
Step 29 - Version A: Installing the Wi-Fi antenna: parts preparation .....	83
Step 30 - Version A: Installing the Wi-Fi antenna .....	84
Step 31 - Version B: Connecting the Nextruder cables .....	84
Step 32 - Version B: Wi-Fi antenna holder: parts preparation .....	85
Step 33 - Version B: Installing the Wi-Fi antenna: antenna preparing .....	85
Step 34 - Version B: Installing the Wi-Fi antenna: antenna preparing .....	86
Step 35 - Version B: Installing the Wi-Fi antenna holder .....	86
Step 36 - Version B: XL buddy box covering .....	87

Step 37 - Version B: Installing the Wi-Fi antenna: parts preparation .....	87
Step 38 - Version B: Installing the Wi-Fi antenna .....	87
Step 39 - Haribo time! .....	88
Step 40 - Spoolholder assembly versions .....	88
Step 41 - Version A: Assembling the spool holder: parts preparation .....	89
Step 42 - Version A: Assembling the spool holder: adjusting the nut .....	89
Step 43 - Version A: Assembling the spool holder .....	90
Step 44 - Version A: Mounting the spool holder assembly .....	90
Step 45 - Version B: Assembling the spool holder: parts preparation .....	91
Step 46 - Version B: Assembling the spool holder: adjusting the nut .....	91
Step 47 - Version B: Assembling the spool holder .....	92
Step 48 - Version B: Preparing the spool holder .....	92
Step 49 - Version B: Mounting the spool holder assembly .....	93
Step 50 - Almost done! .....	93
<b>Manual changelog XL Dual-Head (Semi-Assembled) .....</b>	<b>94</b>
Step 1 - Version history .....	95
Step 2 - Changes to the manual (1) .....	95
Step 3 - Changes to the manual (2) .....	96
Step 4 - Changes to the manual (3) .....	96
Step 5 - Changes to the manual (4) .....	97
Step 6 - Changes to the manual (5) .....	97
Step 7 - Changes to the manual (6) .....	98

# 1. Introduction



## STEP 1 General information



**⚠ NOTE: The package is heavy!**  
Always ask another person for help with handling.

● We're recommending a **bright light above your workbench**. Some parts of the printer are dark and inadequate light could make the assembly process more difficult.

## STEP 2 Tools in the package



● **The package includes:**

**i** Some of the tools are intended primarily for regular printer maintenance. You won't need them for this manual. At the beginning of each assembly chapter is a list of the necessary tools.

● Torx T10 screwdriver

● 2.5mm Allen key

● 3.0mm Allen key

● Philips PH2 screwdriver

● **The printer's package contains a lubricant, which is intended for maintenance.** No need to apply it during the assembly. There is a dedicated online manual [Regular printer maintenance](#).

### STEP 3 Labels guide



- All the boxes and bags including parts for the build are labeled.
- The amount of parts is written on the label. This number is included in the total number of each type of part.

### STEP 4 Cheatsheet



- Your package contains a letter, on the back of which is a Cheatsheet with drawings of all the necessary fasteners.
- The frame covers are 1:1 scale, so you can compare the size by placing the frame cover on the paper to make sure you are using the correct type.
- ⓘ You can download it from our site [prusa.io/cheatsheet-xl](https://prusa.io/cheatsheet-xl). Print it at 100 %, don't rescale it, otherwise, it won't work.

## STEP 5 Front, left, right and rear side



**⚠ IMPORTANT:** The XL printer is large and it is almost impossible to have the entire body in every single picture. Throughout the manual, we will use terms to describe the side you will be working on:

- **Front side** - here are two M3nE nuts inside extrusion and a place for future xLCD screen assembly.
- **Left side** - can be recognized thanks to the **safety sticker** near its edge.
- **Right side** - opposite to the left side, there is **no safety sticker** on this side.
- **Rear side** - the remaining side, which will be used for the future **PSU assembly**, there is a trapezoidal printed part on each edge.

## STEP 6 Transportation foam pads





**⚠ Never slide the bearing out of the rail, you may lose the bearing balls!**

- Each motor axis has transportation protective foam pads.
- Take the foam pad off from both motors.
- Take off the bottom green linear stopper from the rail.
- Keep the upper green linear stoppers in the rail.
- **i** The green linear stopper will be used only during the assembly process. Once the printer is assembled, we will remove it (there is a step in the manual).

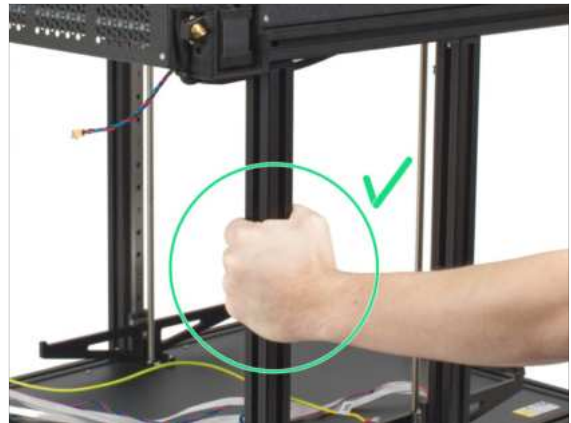
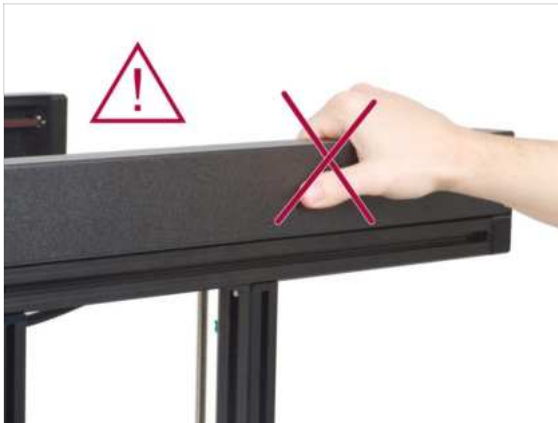

## STEP 7 Manipulating with the printer







 **Never manipulate the printer by using the upper metal flanges. You can damage the LED lights hidden inside.**

 During the assembly manipulate the base using the extrusions.

## STEP 8 Silicone sock



-  A silicone sock is supplied with each Nextruder package.
-  The main function of a silicone sock is to keep the temperature in the heater block stable, which improves the printer's performance.
  -  Also, it keeps your hotend clean from filament dirt and protects it in case the print detaches from the print surface.
-  You will be asked to install the sock later in this guide.
  -  How to install the sock - [check the article](#).

## STEP 9 CAUTION: Lubricant Handling

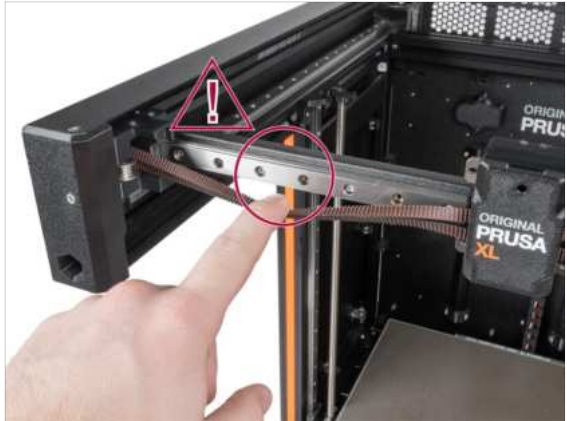
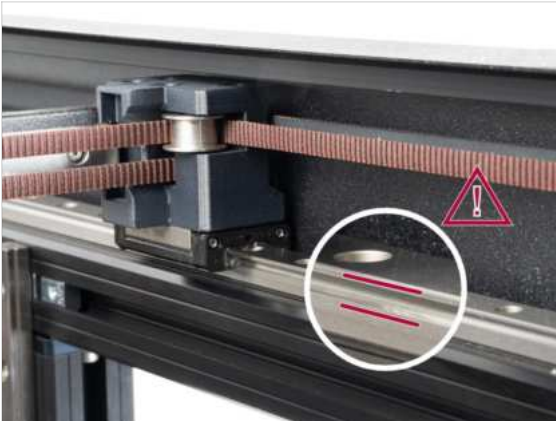

**⚠ CAUTION: Avoid direct skin contact with the lubricant used for the linear rails in this printer. If a contact occurs, wash your hands immediately. Especially before eating, drinking, or touching your face.**

- ◆ Lubricant accumulates in the printer's bearings, mainly in the linear rail channels.

## STEP 10 View high resolution images



**i** When you browse the guide on [help.prusa3d.com](https://help.prusa3d.com), you can view the original images in high resolution for clarity.

- ◆ Just hover your cursor over the image and click the Magnifier button ("View original") in the top left corner.

## STEP 11 We are here for you!

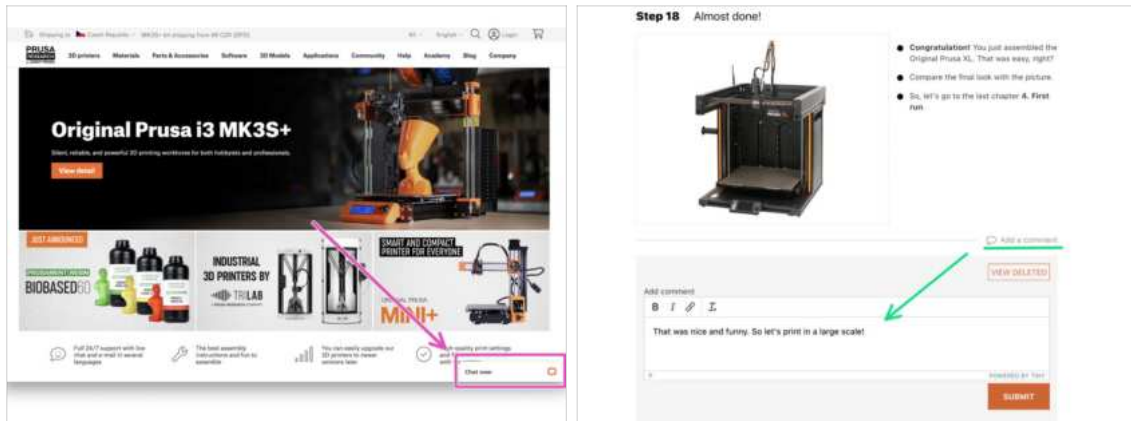

- Lost in the instructions? Missing screw or cracked printed part? **Let us know!**
- You can contact us using following channels:
  - Using comments under each step.
  - Using our 24/7 live chat at [shop.prusa3d.com](https://shop.prusa3d.com)
  - Writing an email to [info@prusa3d.com](mailto:info@prusa3d.com)

## STEP 12 Reward yourself



- ◆ Building the XL printer is definitely a challenge. So it is important to reward yourself after the difficult parts of the manual. **That's why we included a bucket of Haribo bears in the package!**
- ⓘ After completing each chapter or challenging section of the chapter, you will be prompted to replenish energy for the following steps.
- ⚠ **Don't eat all the bears before you start or at once!** Not following instructions will have serious consequences, we are currently assembling **Prusa Haribo tactical squad** for this matter.
- ⚠ **Do not eat any of the Haribo Bears now!** It is **VERY IMPORTANT** to distribute the amount correctly during assembly. We tried all sorts of combinations of quantities. Finally, we reached a successful result.
- ◆ All right, eat one gummy bear. It will give you energy to start the assembly. ;) **But just one!**
- ◆ Are you ready to get started on the assembly? Let's move on to chapter **2. Base & Side frame assembly.**

## 2. Base & Side frame assembly



## STEP 1 Tools necessary for the next steps

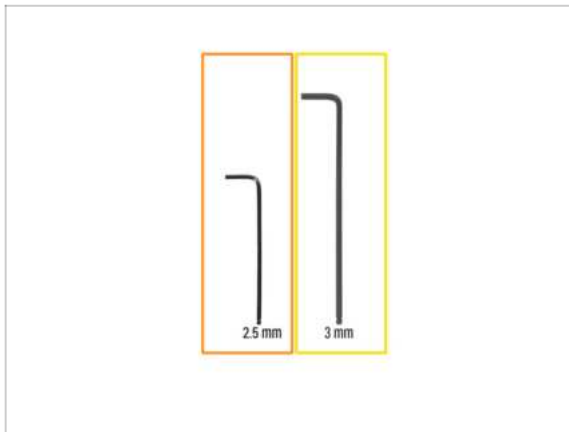

- ◆ For this guide, please prepare:
- ◆ 2.5mm Allen key
- ◆ 3mm Allen key

## STEP 2 Base frame parts preparation



### ◆ For this chapter, please prepare:

- ◆ XL base (1x)
- ◆ M4x12 screw (8x)
- ◆ XL rear extrusion (2x)
- ◆ Left Z-Axis fixed (1x)
- ◆ Right Z-Axis rotary (1x)



**It is important to assemble the Z-axis parts in correct order. This guide will remind you, but keep it in mind.**

### STEP 3 Extrusion alignment

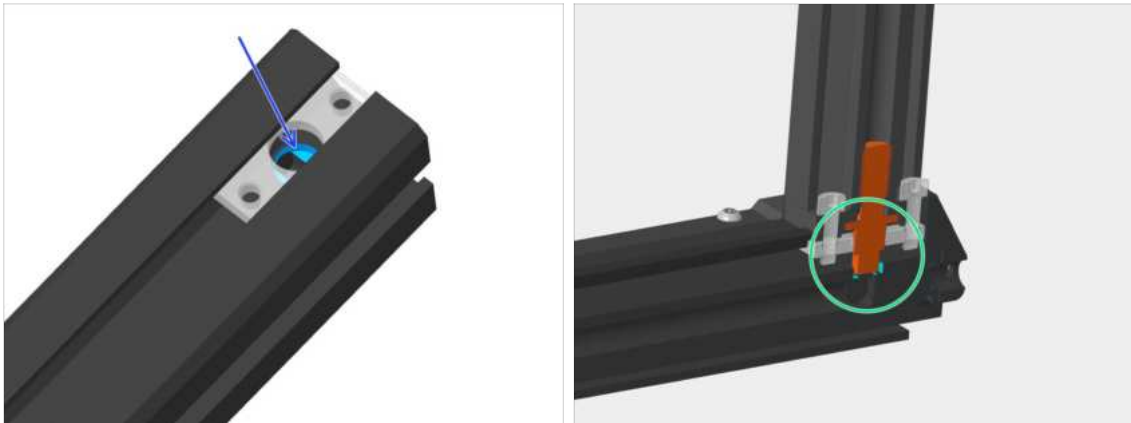

- ◆ There's a hole in the extrusion that the pin has to fit into.
- ◆ Check that the pin fits into the hole in the extrusion
- ⓘ Repeat this alignment check always, when you will be assembling extrusions together throughout this manual. Improper alignment will cause visible gaps between extrusions.

### STEP 4 Right rear extrusion assembly



- ◆ Turn the right side (no sticker) of the base towards you. Use the extrusion plastic cap as a guide.
- ◆ Make sure one profile insert is slid all the way to the back.
- ⚠ **Be careful while connecting extrusions together, avoid scratching them. The orientation of the silver pin doesn't matter.**
- ◆ Before you connect the extrusions together, see the protrusion in the "standalone" extrusion. This part must be aligned with the "groove" in the base extrusion. See the bubble in the third picture.
- ◆ Take one rear extrusion prepared earlier and slide its pin into the profile insert. Mind the correct orientation of the extrusion (protrusion vs groove).
- ◆ There might be a slight gap between parts, we will address this in the next step.

## STEP 5 Securing the right rear extrusion



- ◆ Insert two M4x12 screws, from opposite sides of the extrusion.
- ⚠ **Proceed carefully with the 3mm Allen key, avoid scratching the frame.**
- ⓘ Tighten the screws until you reach the metal insert, then stop! We will do the final tightening later on using the torque indicator.
- ◆ Use the longer side of the 3mm Allen key and tighten the M4x12 screws on both sides.

## STEP 6 Left rear extrusion assembly



- ◆ Let's assemble the second rear extrusion. Turn the left side (with the safety sticker) of the base towards you and focus on the rear side. Use the extrusion plastic cap as a guide.
- ◆ Make sure one profile insert is slid all the way to the back.
- ◆ Insert the Z-Axis-back into the profile insert in the back of a base.
- ◆ Insert two M4x12 screws from opposite sides of the extrusion.
- ⚠ **Proceed carefully with the 3mm Allen key, avoid scratching the frame.**
- ⓘ Tighten the screws until you reach the surface of the metal plate, then stop! We will do the final tightening later on using the torque indicator.



## STEP 7 Z-Axis assembly clarification

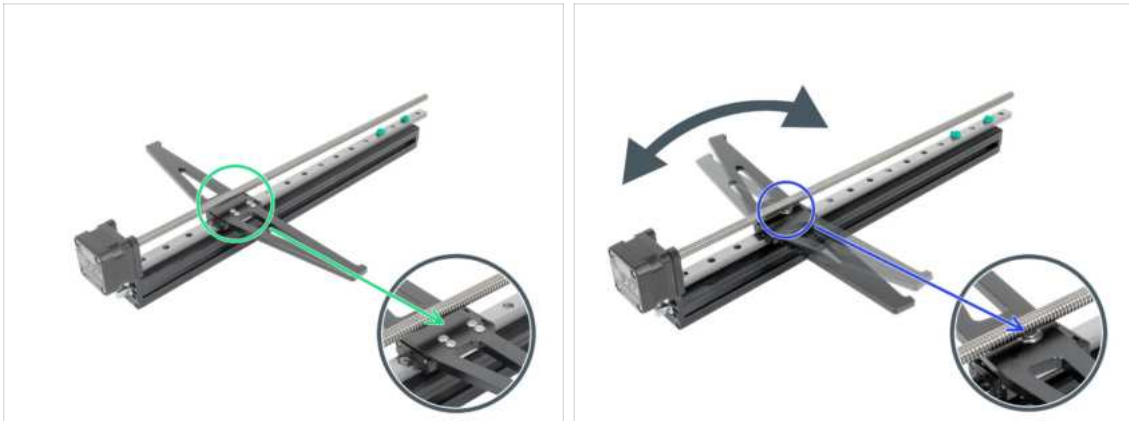

- i** You have received two Z-axis assemblies, pay close attention to each assembly:
- ◆** Z-Axis fixed: This assembly doesn't rotate. Instead, it's held in place with screws. You'll notice these screws holding it in place. **This Z-axis assembly will be installed first on the left side of the printer.**
  - ◆** Z-Axis rotary: This assembly rotates and has a single bearing in the middle, which is visible and allows the axis to rotate smoothly. **This Z-axis assembly will be installed as a second on the right side of the printer.**
- ⚠ ATTENTION:** Pay close attention to the proper location of the Z-Axis assembly.







## STEP 8 Z-Axis fixed assembly



- ◆** Stay on the left side of the base. Use the safety sticker as a guide.
  - ◆** Now, let's install the Z-Axis fixed in the cutout on the left side.
  - ◆** Align the second profile insert with the opening.
- ⚠ ATTENTION:** Pay close attention to the proper location of the Z-Axis. **The Z-Axis fixed must be used on the left side (the heatbed carrier should not rotate and should have multiple screws).**
- ◆** Guide the Z-Axis fixed motor cable through the opening in the base.







## STEP 9 Securing the Z-Axis fixed



-  **Be careful, don't pinch any cables!**
-  Carefully insert the Z-Axis fixed into the base frame. The motor must perfectly fit into the opening and the pin on the extrusion must fit into the profile insert.
-  Insert two M4x12 screws, from opposite sides of the extrusion.
-  Use the longer side of the 3mm Allen key and tighten the M4x12 screws on both sides.
-  Tighten the screws until you reach the surface of the metal plate, then stop! We will do the final tightening later on using the torque indicator.
-  **Be careful with the 3mm Allen key, you may scratch the frame.**







## STEP 10 Z-Axis rotary assembly



-  **Be careful, don't pinch any cables!**
-  Turn the base, so that the right side (no safety sticker) is facing towards you.
-  Now, let's install the Z-Axis rotary into the opening on the right side.
-  Align the second profile insert with the opening.
-  **ATTENTION:** Pay close attention to the proper location of the Z-Axis. The Z-Axis rotary must be used on the right side (the heatbed carrier should rotate and should have only one screw).
-  Guide the Z-Axis rotary motor cable through the opening in the base.





## STEP 11 Securing the Z-Axis rotary



-  **Be careful, don't pinch any cables!**
-  Carefully insert the Z-Axis rotary into the base frame. The motor must perfectly fit into the opening and the pin on the extrusion must fit into the profile insert.
-  **Double-check, that the Z-Axis rotary is on the right side of the base frame.**
-  Insert two M4x12 screws, one from opposite sides of the extrusion.
-  **Be careful with the 3mm Allen key, you may scratch the frame.**
-  Tighten the screws until you reach the surface of the metal plate, then stop! We will do the final tightening later on using the torque indicator.
-  Use the longer side of the 3mm Allen key and tighten the M4x12 screws on both sides.

## STEP 12 Torque indicator: parts preparation



-  **For the following steps, please prepare:**
-  Torque-indicator (1x)
-  Allen-key-handle (1x)
-  Allen key 3mm *use the one already prepared*

### STEP 13 Assembling the Torque indicator



- ◆ Insert the 3mm Allen key into the torque indicator.
- ◆ Put on the Allen key handle from the other side.
- ◆ The assembled torque indicator looks like this.

### STEP 14 Final tightening with torque indicator



- ⚠ **Attention: Do not overtighten the screws over the torque indicator scale!**
- ◆ Tighten the screw till you reach the "OK" line and the 3mm Allen key is slightly bent.
- ◆ Proceed the same way on all eight M4x12 screws inserted in the extrusions.
- ⓘ Do not throw the torque indicator away, you will need it in the next chapter.

## STEP 15 Haribo time!



**⚠** Carefully and quietly open the bag with the Haribo sweets. A high level of noise might attract nearby predators!

**◆** Take one gummy bear. **I said just one!**

**i** **Did you know that** Gummy bears were first created by a German candy maker named Hans Riegel in the 1920s?

## STEP 16 xLCD: parts preparation



**i** Starting from September 2024, you may receive a new injection molded xLCD.

**◆** For the following steps, please prepare:

**◆** Injection molded xLCD assembly (1x)

**◆** M3x10 screw (2x)

**◆** Older versions:

**◆** Printed xLCD assembly (1x)

**◆** M3x16 screw (2x)

## STEP 17 xLCD cable covers: parts preparation

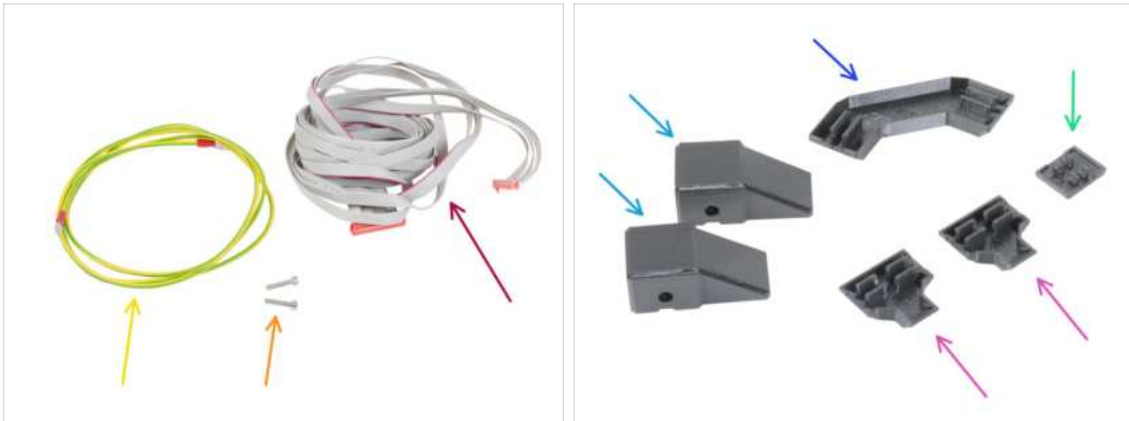

**i** For the following steps, please prepare:

- xLCD PE cable (1x)
- xLCD cable (1x)
- M3x10 screw (2x)
- Frame-rear-cover (2x)
- Frame-corner-cable-cover (1x)
- Z-motor-cable-bottom-cover(2x)
- xLCD-cable-bottom-holder (1x)

**i** The list continues in the next step...

## STEP 18 Extrusion covers: parts preparation

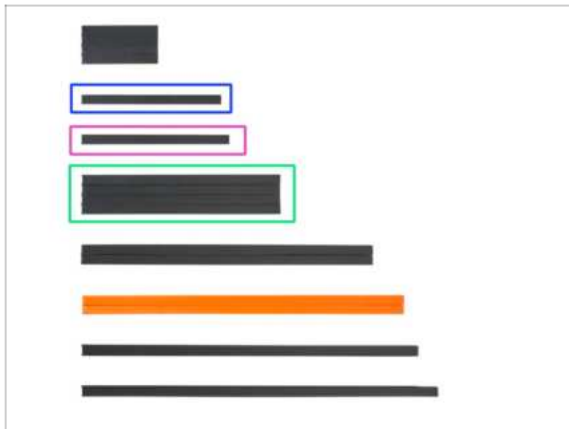

- xLCD display (1x)
- M3x16 screw (2x)
- Stack all the plastic extrusion covers on an empty clean area. Sort them by length, as in the picture. For the following steps, prepare:
  - Extrusion cover 172 mm (1x)
  - Extrusion cover 182 mm (1x)
  - Extrusion cover 243 mm (2x)

**i** Tip: To measure the extrusion covers, use the included paper cheatsheet.

## STEP 19 Mounting the xLCD



- Locate the M3nEs nuts in the front base extrusion and place the xLCD assembly in front of it.
- Insert the M3x10 (older: M3x16) screw into the right xLCD support.
- ⚠ **Do not tighten the screws fully, a few turns are enough for now.**
- Use the 2.5mm Allen key to tighten the M3x16 screw into the M3nEs nut in the frame.
- Insert the second M3x10 (older: M3x16) screw from the left side and tighten it, but not overtighten. We will adjust the correct position of the xLCD assembly later on.

## STEP 20 Aligning the xLCD



- ⚠ **Aligning the xLCD to the center is recommended** or you can go slightly to the right side. Moving the xLCD to the left is not recommended as the cables won't be long enough.
- Align the xLCD approximately to the center of the base.
- Tighten the left M3x10 (older: M3x16) screw with the 2.5mm Allen key.
- Tighten the right M3x10 (older: M3x16) screw with the 2.5mm Allen key.





## STEP 21 xLCD assembly versions



 Take a look at the xLCD, there are two variants:

 Version A: faston on the bottom right

 Version B: faston on the top left

 Injection molded xLCD is Version B.

## STEP 22 Version A: Installing the xLCD PE cable



 Turn the printer to the left side so that the bottom of the base is facing you.

 It is recommended to place a cardboard pad under the side of the base to protect the workbench and the frame from scratch.

 Take a closer look at the rear side of the xLCD assembly and locate the PE Faston on the xLCD board. Slide the PE cable connector all the way onto the PE Faston.

 Your version of the PE faston may be on the upper side of the xLCD. Slide the PE cable connector all the way onto the PE faston. The function is the same. You can continue through the manual.



## STEP 23 Version B: Installing the xLCD PE cable



- ◆ Turn the printer to the left side so that the bottom of the base is facing you.
  - ⓘ It is recommended to place a cardboard pad under the side of the base to protect the workbench and the frame from scratch.
- ◆ Take a closer look at the rear side of the xLCD assembly and locate the PE Faston on the xLCD board.
- ◆ Slide the PE cable connector all the way onto the PE Faston.





## STEP 24 xLCD PE cable management



- ◆ Push the PE cable into the frame.
- ◆ Guide the PE cable through the extrusion. The PE cable shouldn't be stretched, this is important for the next steps.





## STEP 25 xLCD cable routing



-  **The xLCD cable connector has a locking latch that has to face the red triangle near the xLCD connector.**
-  Connect the xLCD cable to the xLCD slot on the board.
-  Make sure, that cable is not twisted.
-  **Make sure the xLCD cable is connected in the same orientation as seen in the picture. Otherwise, your display won't work!**

## STEP 26 Routing the cables



-  **Make sure, that the xLCD cable is not twisted.**
-  Insert the xLCD cable into the frame, copy the line of the PE cable, and cover the PE cable.
-  Guide all xLCD cables as close to corner as possible.
-  Once in the corner flip the cables along the upper edge. See the picture.
-  Insert the xLCD-cable-bottom-holder into the frame.

## STEP 27 Routing the cables



- ◆ Insert the xLCD cable far into the frame to create a gap for the frame-corner-cover.
- ⚠ **Be careful, don't pinch any cables!**
- ◆ Gently insert the xLCD-cable-bottom-cover **into the vertical frame**.
- ⚠ **The xLCD-cable-bottom-cover has to be in line with the horizontal frame. Don't insert the plastic cover into the horizontal frame.**
- ◆ Insert the Extrusion cover 172mm to the frame and push it up to the xLCD-cable-bottom-cover.
- ◆ Fully insert the Extrusion cover 172 mm into the frame.

## STEP 28 Routing the cables







- ⚠ **Beware of cable pinching!**
- ◆ Push up the xLCD-cable-bottom-holder to the LCD-cable-bottom-cover.
- ◆ Take the xLCD and PE cables and gently push them up.
- ⓘ Make sure the cable loop is not too large.

## STEP 29 Horizontal cable inserting





 **Be careful, don't pinch any cables!**

-  Press the xLCD-cable-bottom-cover into the extrusion.
-  Guide the xLCD and the PE cables through the extrusion.
-  Remove the rubber band from the cable.
-  Insert the Z motor cable into the extrusion.
-  Guide the cables together through the extrusion, as in the picture.

## STEP 30 Corner frame cover





 **Be careful, don't pinch any cables!**

-  Insert the 182mm extrusion cover into the extrusion.
-  Push the extrusion cover to the left side.
-  Fully insert the 182mm extrusion cover right next to the corner-frame-cover.

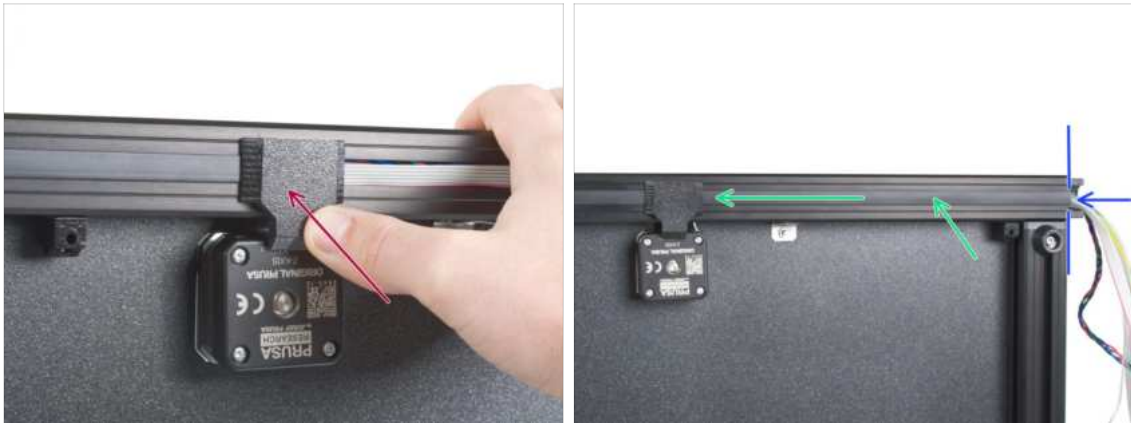
### STEP 31 Inserting Z-motor-cable-bottom-cover



 **Be careful, don't pinch any cables!**



-  Push the Z-motor-cable-bottom-cover into the frame.
-  Insert the Extrusion cover 243mm. Push and slide it to the left.
-  The extrusion cover has to be aligned with the end of the extrusion.

### STEP 32 Preparing the cables for rear cover



-  Gently bend the cables over the corner and insert them into the extrusion. Start with the Z motor cable and then proceed with xLCD and PE cables. Gently bend the xLCD cable over the corner and insert it in the extrusion.

 **Be careful, don't pinch any cables!**

-  Attach the frame-rear-cover on the printer. Make sure it perfectly fits on the extrusions.
-  Secure it with the M3x10 screw.

## STEP 33 Inserting the second motor cable



- ◆ Turn the printer so that you have the second motor on the top side.
- ⓘ It is recommended to place a cardboard pad under the side of the base to protect the workbench and the frame from scratch.
- ◆ Remove the rubber band from the cable.
- ◆ Insert the motor cable in the extrusion. Make sure it goes perpendicular from the motor to the extrusion first.
- ◆ Insert the Extrusion cover 243mm. Push and slide it to the right.
- ◆ Push the Z-motor-cable-bottom-cover into the frame.
- ⚠ Mind the correct direction. **The motor cable guide the back of the printer (not to the xLCD screen).**

## STEP 34 Inserting Z-motor-cable-bottom-cover



- ⚠ **Be careful, don't pinch any cables!**
- ◆ Gently bend the cable over the corner and guide it through the extrusion.
- ◆ Attach the frame-rear-cover to the frame. Make sure it fits perfectly on the extrusions.
- ◆ Secure it with the M3x10 screw.
- ◆ Keep the printer on the side, with the rear side facing towards you. We will continue working on this part of the printer in the next chapter.



### STEP 35 Haribo time!



- ◆ Eat one to five gummy bears.
- ⓘ **Did you know that** the original gummy bears were inspired by the dancing bears of Europe, and Riegel named them "Gummibärchen," which means "little rubber bears" in German?

### STEP 36 Well done!



- ⓘ The photo is for informational purposes only, keep the printer on its side for the next chapter.
- ◆ **Great job!** You successfully finished the base of your XL!
- ◆ Go to the next chapter **3. Core XY & Back assembly.**
- ⓘ The protective foam pads are back on the linear rails by accident, don't put yours back.

### 3. CoreXY & Back assembly

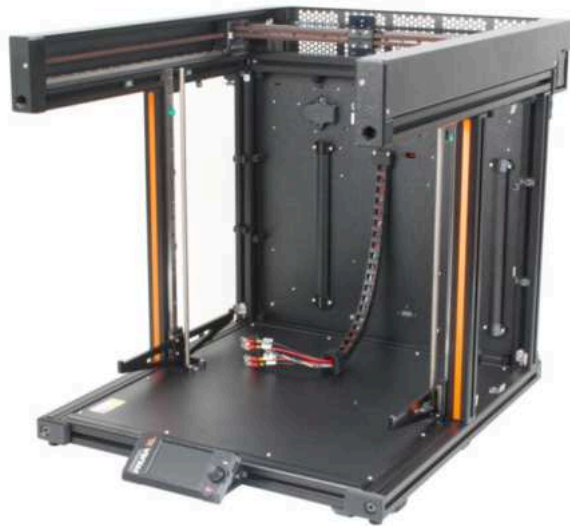



## STEP 1 Tools necessary for this chapter



◆ For the following steps, please prepare:

- ◆ T10 screwdriver
- ◆ 2.5mm Allen key
- ◆ 3mm Allen key

## STEP 2 Torque indicator disassembly



- ① For the following steps, we need a 3mm Allen key without the torque indicator.
- ◆ Take the assembled torque indicator.
- ◆ Pull out the plastic handle.
- ◆ Pull out the 3mm Allen key from the torque indicator.
- ① Keep the 3D printed indicator for later use.

### STEP 3 Installing the CoreXY assembly: parts preparation



◆ For the following steps, please prepare:

- ◆ CoreXY assembly (1x)
- ◆ M4x12 screw (8x)
- ◆ M3x10 screw (2x)
- ◆ M3nEs nut (6x)

### STEP 4 How to insert the M3nEs nuts

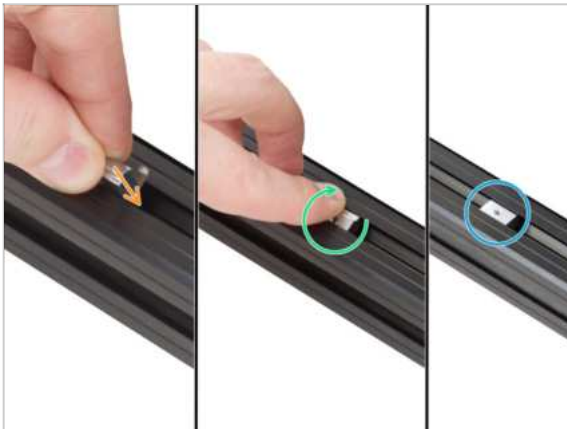

- ◆ Insert the nut all the way into the extrusion from the top. See the orientation of the spring (the metal sheet on the nut).
- ◆ With your finger, turn the nut and align it with the extrusion. The springs on the nut should be facing down.
- ◆ The M3nEs nut is installed.

### STEP 5 CoreXY assembly



- ◆ Measure approximately 23 cm (9") from the right extrusion.
- ◆ Insert three M3nEs nuts into the left extrusion.
- ◆ Insert three M3nEs nuts into the right extrusion.

## STEP 6 Installing the CoreXY assembly

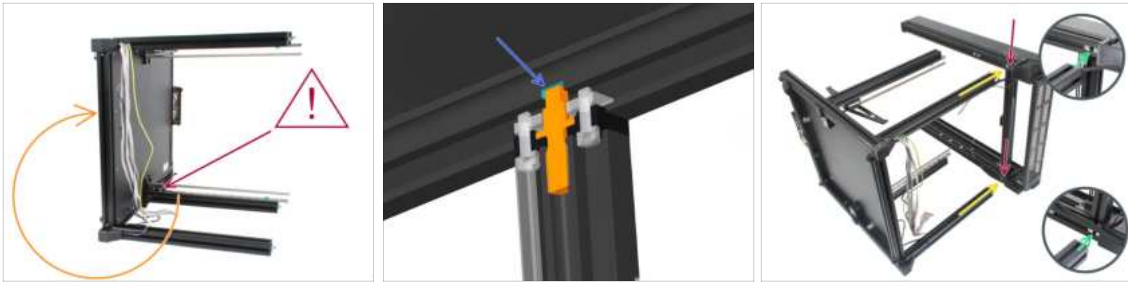

**⚠** Double-check that the Z-axis fixed and rotary assemblies are in the correct positions. In the picture, **the Z-axis is fixed at the bottom, which is correct. Check your printer!**

**🟡** **Are you left or right-handed?** The printer should be already laying on its left side from the previous chapter. If you are a left-hander rotate it carefully on the opposite right side (see the picture). We are going to attach the upper CoreXY part and tighten the screws to interconnect both parts together. The instructions are the same, **choose the side which suits you better for tightening the screws.**

**ⓘ** It is recommended to place a cardboard pad under the side of the base to protect the work bench and the frame from scratch.

- 🟡** There's a hole in the extrusion that the pin has to fit into.
- 🟠** Move the rear profile insert inside each extrusion of the CoreXY to the rear side of the assembly.
- ⬛** Slide the remaining inserts approximately to the middle. Precise position will be addressed later.
- 🟡** Rotate the CoreXY on its longer side and put it near the top of the four base extrusions.
- 🟢** The rear profile inserts must be facing against the rear extrusions. Do not push the CoreXY all the way in until you are prompted.

## STEP 7 Installing the CoreXY assembly



**⚠** **Be careful while attaching the extrusions and CoreXY, avoid scratching them.**

- 🟠** First, slide the CoreXY assembly on both rear extrusions.
- 🟡** Align the remaining profile inserts with both Z-axis extrusions.
- 🟢** Slide the CoreXY on both Z-axis extrusions.

## STEP 8 Securing the CoreXY



- ◆ Insert the M4x12 screws into both holes. Same way as you did with the base.
- ⚠ **Proceed carefully with the 3mm Allen key, avoid scratching the frame.**
- ⓘ There might be a slight gap between parts, we will address this in the next step.
- ◆ Tighten the screws until you reach the metal plate, then stop! We will do the final tightening later on using the torque indicator.
- ◆ Repeat this procedure on the three remaining extrusions.

## STEP 9 Manipulating with the printer

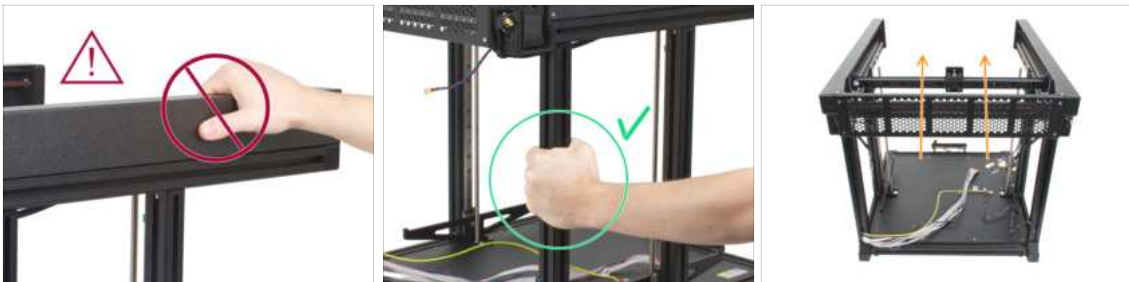

- ⚠ **Never manipulate the printer by using the upper metal flanges. You can damage the LED lights hidden inside.**
- ◆ Manipulate the base using the extrusions.
- ◆ Rotate the base back on its feet (the Core XY is facing up).

## STEP 10 Torque indicator: parts preparation

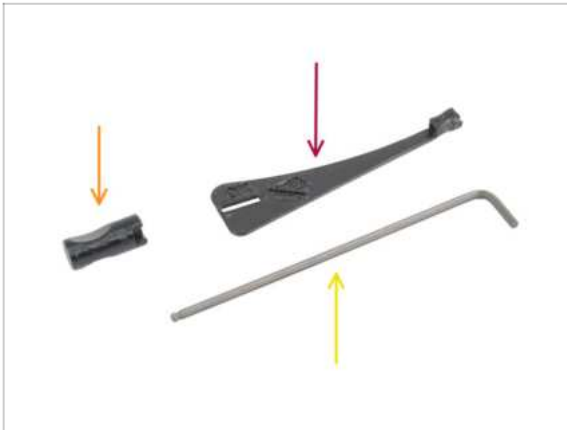

● For the following steps, please prepare:

- Torque-indicator (1x)
- Allen-key-handle (1x)
- Allen key 3mm *use the one already prepared*

## STEP 11 Assembling the Torque indicator



- Insert the 3mm Allen key into the torque indicator.
- Put on the Allen key handle from the other side.
- The assembled torque indicator looks like this.

## STEP 12 Securing the CoreXY



- Prepare the 3mm Allen key with the torque indicator.
- Insert the shorter side of the 3mm Allen key into the screw securing the CoreXY assembly.
- Tighten the screw till you reach the "OK" line and the 3mm Allen key is slightly bent.
- Repeat this procedure on all M4x12 screws inserted into the Z-axis extrusions.

## STEP 13 Haribo time!



- Take one gummy bear.
- ⓘ **Did you know that** Gummy bears were initially sold as a novelty item and gained popularity in Germany before spreading to other countries?

## STEP 14 Securing the left linear rail



- On the left side of the CoreXY, there are three M3nEs nuts in the extrusion. Slide the middle M3nEs nut behind the linear rail. Align its hole with the hole in the linear rail.

 **Double check you have used the middle nut.**

- Insert the M3x10 screw into the upper hole.
- Tighten the M3x10 screw with a 2.5mm Allen key.

## STEP 15 Securing the right linear rail



- On the right side of the CoreXY there are three M3nEs nuts in the extrusion. Slide the middle nut behind the linear rail. Align its hole with the hole in the linear rail.

 **Double check you have used the middle nut.**

- Insert the M3x10 screw into the upper hole.
- Tighten the M3x10 screw with a 2.5mm Allen key.



## STEP 16 Earthing-connectors: parts preparation

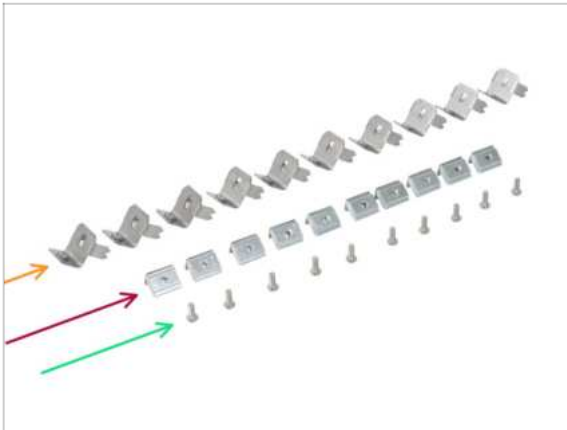

◆ For the following steps, please prepare:

- ◆ Earthing-connector (10x)
- ◆ M3nEs nut (10x)
- ◆ M3x8rT screw (10x)

## STEP 17 Inserting the M3nEs nuts into extrusions

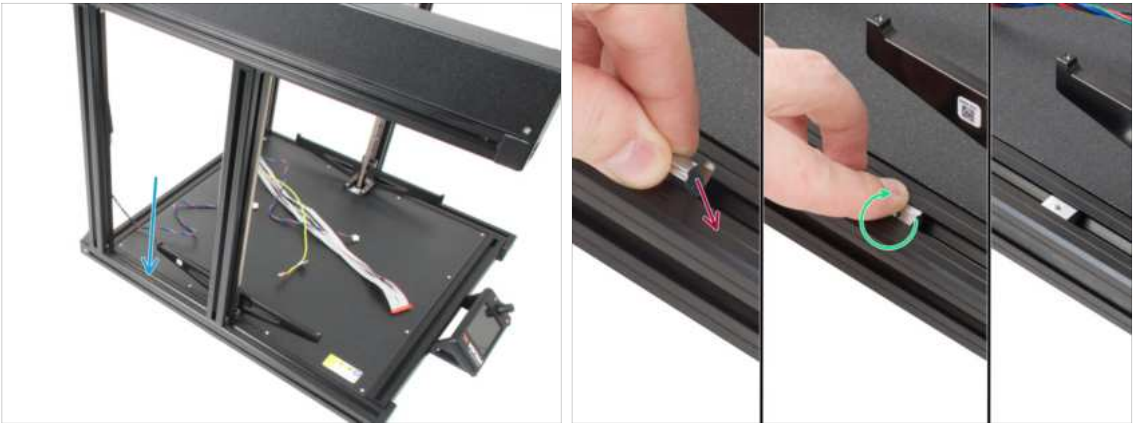

- ① Turn the printer so that the left side is facing towards you. Use the safety sticker as a guide.
- ◆ Focus on the left half of the extrusion base, where we will install the M3nEs nut:
  - ◆ Insert the nut all the way **into the extrusion from the top**. See the orientation of the spring (the metal sheet on the nut).
  - ◆ With your finger, turn the nut and align it with the extrusion. The springs on the nut should be facing down.
- ① The exact position of the nut will be adjusted later on. For now, slide it approximately to the center of the extrusion.



## STEP 18 Grounding the Frame



- Make sure the M3nEs nut is facing up like in the picture.
  - Place the Earthing-connector onto the M3nEs nut. The vertical part must be facing out from the printer.
  - Insert the M3x8rT screw and secure both parts together with a T10 screwdriver.
- ⚠ **Do not tighten the screw completely, we might need to adjust the position of the Earthing-connector in the extrusion later on. 4-5 turns are enough.**

## STEP 19 Grounding the sides



- ⓘ Repeat the same procedure to install the Earthing-connectors to the top and side extrusions.
- Start by inserting the M3nEs nuts in both vertical extrusions on the left side. Roughly 2 cm from the bottom extrusion.
- Continue by inserting the M3nEs nut in the extrusions on the top side. Slide it approximately to the center of the extrusion.
- Now place the Earthing connector onto the M3nEs nut. The vertical part must be facing out from the printer.
- Proceed the same way with the extrusions on the right side of the frame.
- ⓘ The exact position of each nut will be adjusted later on.
- ⚠ **Make sure all the connectors are facing out from the printer as in the picture.**
- ⓘ Do not tighten the screw firmly, we might need to adjust the position of the Earthing-connector in the extrusion later on. 4-5 turns are enough.

## STEP 20 Grounding the rear side

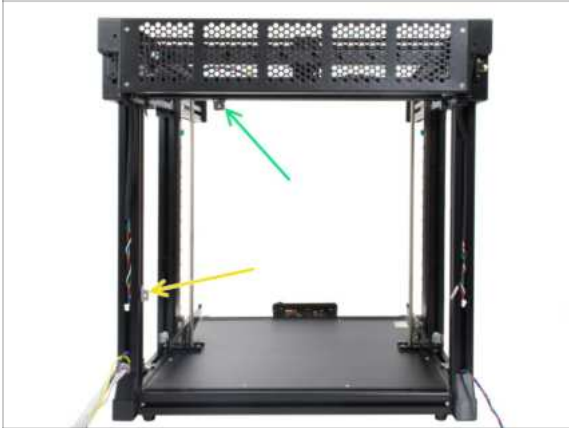

- ⓘ Rotate the rear side of the printer towards you. Repeat the process of inserting the M3nEs nuts, Earthing-connectors and M3x8rT screws described in the previous steps.
- 🟡 Insert the M3nEs nut in the vertical extrusion on the left side. Roughly 6 cm from the bottom extrusion.
- 🟢 Continue by inserting the M3nEs nut in the extrusion on the top side. Move it to roughly the initial one-third from left.
- ⚠️ **Make sure all the connectors are facing out from the printer as in the picture.**
- ⓘ Do not tighten the screw firmly, we might need to adjust the position of the Earthing-connector in the extrusion later on. 4-5 turns are enough.

## STEP 21 Cover-clips: parts preparation



- ⬢ For the following steps, please prepare:
  - 🟠 Cover-clip (20x)

**STEP 22** Attaching the cover-clips

- ⓘ This step explains how to insert and lock the cover-clip. The exact position of each clip will be described in the upcoming steps.
- ⓘ Use any extrusion closest to you.
- ◆ Hold the clip so that its longer side is aligned vertically. Then insert the cover-clip into the extrusion.
- ◆ Once the clip is in the extrusion, rotate it 90 degrees. Both directions are fine, the clip is symmetrical
- ◆ Now, the cover-clip is secured.
- ⓘ Note that due to tolerances, the clip might not hold in place. This is OK, its main purpose is withstand being pulled/pushed and it will be secure in place using a screw.

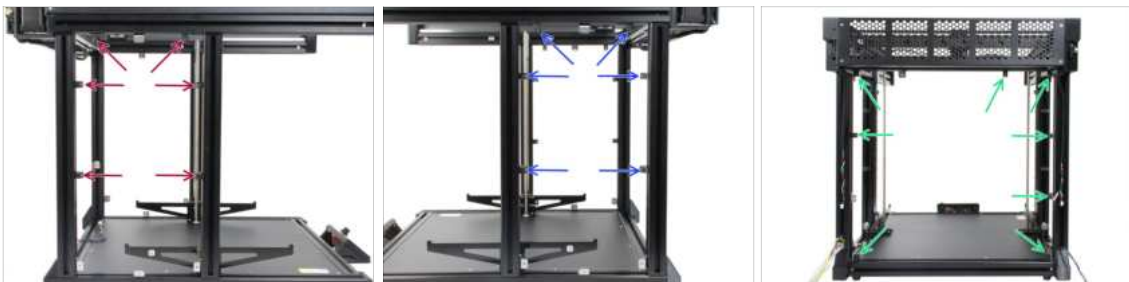
**STEP 23** Attaching the cover-clips

- ◆ Insert the cover-clips in places, use the pictures as reference:
  - ◆ 6x on the left side
  - ◆ 6x on the right side
  - ◆ 8x on the rear side
- ⓘ The final position of each cover-clip will be adjusted later on.

## STEP 24 XL rear panel: parts preparation



◆ For the following steps, please prepare:

- ◆ XL rear panel (1x)
- ◆ Extrusion cover 354 mm (2x)
- ◆ M3x8rT screw (10x)

## STEP 25 Removing the electronics casing



- ⓘ In order to be able to plug in cables, we need to open the box with electronics. **Don't throw away the covers or the fasteners!**
- ◆ Loosen slightly all four screws on the XL Buddy box cover. No need to remove them completely. Slide the cover upwards and remove it.
- ◆ Release and remove four M3x5rT screws on the upper cable cover.
- ◆ Take the entire cover off.
- ⓘ Place both covers somewhere safe, we will put them back soon.

## STEP 26 Attaching the XL rear panel



- ⚠ Hold the XL rear panel with your hand during assembly! It is not secured with any screws.**
- 🟡 For easier assembly place the bottom edge of the XL rear panel approximately 2 cm (0.8 inches) behind the bottom rear extrusion of the printer base.
- 🟢 Rotate (close) the XL rear panel to the rear side of the printer. **Make sure there is no cable in the way.**
- ⚠ Be careful, don't pinch any cables!**
- 🟢 Carefully slide the XL rear panel up until it stops on the top stops.
- 🟡 Continue by pressing the lower rear panel against the bottom extrusion
- ⬛ Continue to the next step.

## STEP 27 Attaching the XL rear panel



- ⚠ Hold the XL rear panel with your hand during assembly! Until it is secured with screws.**
- 🟡 From the inside of the printer, align the Earthing-connectors with the holes of the rear panel.
- 🟢 If needed release the screw slightly and adjust the Earthing-connector, then tighten it.
- 🟡 From the outside (rear side), insert the M3x8rT screw and secure the rear panel using a T10 screwdriver.

## STEP 28 Installing the XL rear panel



**⚠ Hold the XL rear panel with your hand during assembly! Until it is secured with screws.**

- Insert the M3x8rT screw into the hole and align the Earthing-connector.
- ➡ Fully tighten the screw with the T10 screwdriver.
- Tighten the screw in the M3nEs nut to secure its position.

## STEP 29 Installing the XL rear panel

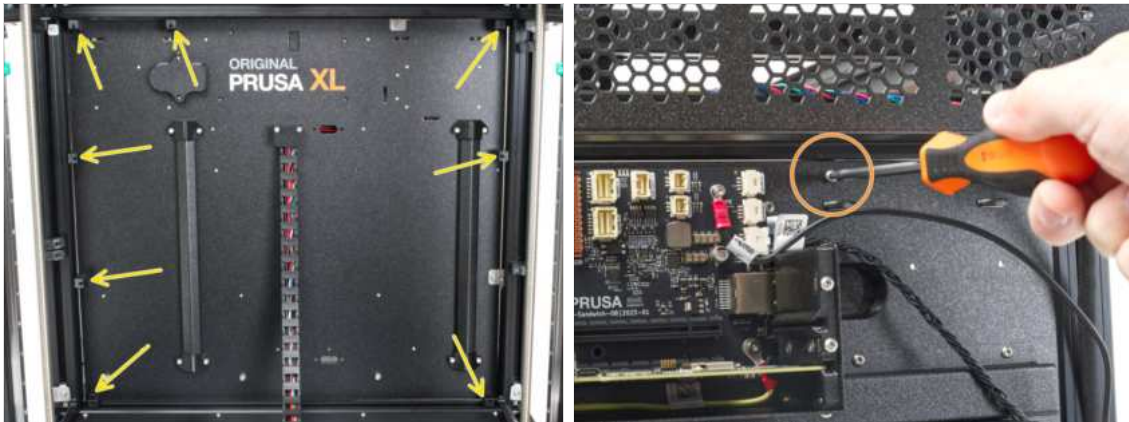

- Inside the printer: Line up all cover-clips with the holes in the rear panel.
- Outside the printer (rear side): Secure the cover-clips with eight M3x8rT screws using a T10 screwdriver.



### STEP 30 Haribo time!



- ◆ Eat one gummy bear.
- ⓘ **Did you know that** gummy bears were one of the first gelatin-based candies to be made in the shape of animals?

### STEP 31 Rear left: cable management

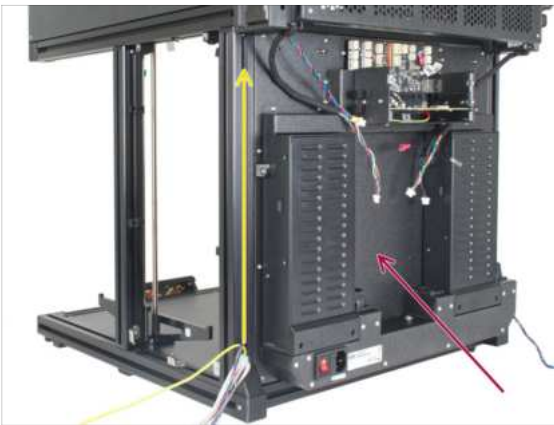

- ⓘ In the following steps, we will focus on routing and connecting all the cables on the rear side.
- ◆ Turn the printer's rear side towards you.
- ◆ On the left edge, start from the bottom. Grab the PE, motor with xLCD cables and gently push them into the extrusion.
- ◆ Secure the cables with the Extrusion cover 354 mm.

### STEP 32 Rear left: PE cable

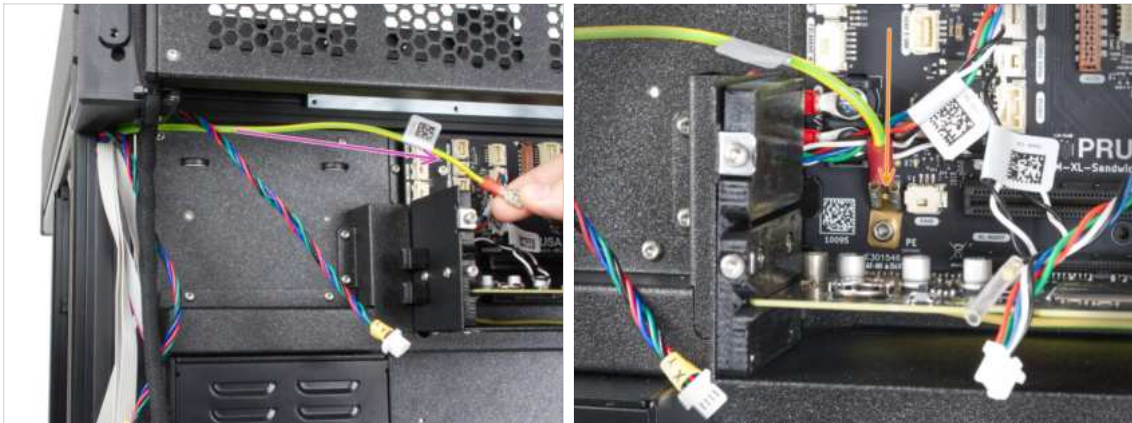

- Take the PE cable.
- Slide (connect) the PE cable to the PE connection on the board.

### STEP 33 Rear left: connecting the cables







- **Connect all cables from the left side in the following order:**
  - XY motor cable (yellow label XY)
  - Z motor cable (yellow label Z)
  - LED light cable
- ⚠ The xLCD cable connector has a locking latch that has to face the triangle near the xLCD connector.
  - xLCD cable
- ⚠ The purple line has to be on the upper side of an xLCD cable. The photo is incorrect, we'll update the photo soon.

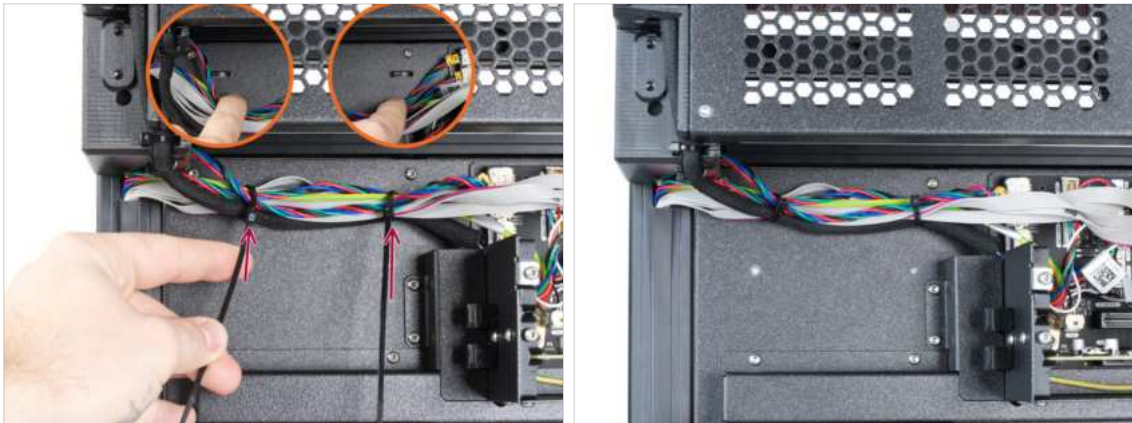

## STEP 34 Rear left: securing the cables





 **ATTENTION: Do not overtighten the zip ties!** Otherwise, you risk damaging the cables.

-  Under the cables are two perforations in the metal sheet.
-  Insert two zip ties through the perforations in the metal sheet to secure the cables. **Tighten them gently.**
-  Cut the excess of the zip ties.
-  Left side is ready for now, let's focus on the right side.

## STEP 35 Rear right: cable management



-  On the right edge, start from the bottom. Grab the motor cable and gently push it into the extrusion.
-  Secure the cable with the Extrusion cover 354 mm.

## STEP 36 Rear right: connecting the cables



◆ Connect all cables from the right side in the following order:

- ◆ XY motor cable
- ◆ Z motor cable
- ◆ LED lights cable

## STEP 37 The Wi-fi antenna versions



- ◆ If your printer has the antenna connector on the right side of the printer (the back of the printer is facing you) -> the antenna is connected. **Please proceed to the next step.**
- ◆ If not, continue to **Installing the frame grounding**

## STEP 38 Version A: Rear right: connecting Wi-Fi Antenna



**i** You may have another version of the Wi-Fi antenna holder (**the cable from the antenna cannot be found now**). A new version of the antenna holder is in [5. Extruder & accessories assembly](#). **Do not install the antenna yet!** Just continue through the manual.

**⚠ ATTENTION:** Be very gentle, the cable and the connector can be damaged if you use excessive force.

- ➊ Remove the connector cover (translucent tube) from the Wi-Fi antenna cable.
- ➋ Connect the Wi-Fi antenna cable connector to the xIBuddy board.
- ➌ Support the board with your finger to prevent it from bending.

## STEP 39 Installing the frame grounding



- ➍ Take a look from the top and on the rear right edge remove the grounding cover from the grounding plug on the CoreXY assembly.
- ➎ Connect the PE cable to the CoreXY grounding plug.

## STEP 40 Rear right: securing the cables



**⚠ ATTENTION:** Do not overtighten the zip ties! Otherwise, you risk damaging the cables.

- Insert two zip ties through the perforations in the metal sheet to secure the cables. **Tighten them gently.**
- Cut the excess of the zip ties.

## STEP 41 Overview of electronics wiring



**⚠ Before proceeding to the next step, check the cable connection according to the picture.**

- XY motor cable
- Z motor cable
- LED cable
- xLCD cable
- PE cable
- Wi-Fi antenna cable

**i** The newest **Wi-Fi antenna cable** will be assembled later in the **5. chapter** of this guide.

**i** The filament sensor cable is already connected to the xBuddy from one side. The other side is free, we'll connect it later.

## STEP 42 Rear electronics covers preparation



● For the following steps, please prepare:

- Rear-cable-management-upper (1x)
- XL-buddy-box-cover (1x)
- M3x5rT screw (4x)

## STEP 43 Rear electronics cover



⚠ **Be careful, don't pinch any cables.**

- Gently attach the Rear-cable-management-upper on a rear side.
- Make sure that no cable is pinched.
- Secure it with four M3x5rT screws using a T10 screwdriver.



## STEP 44 Installing XL buddy box cover

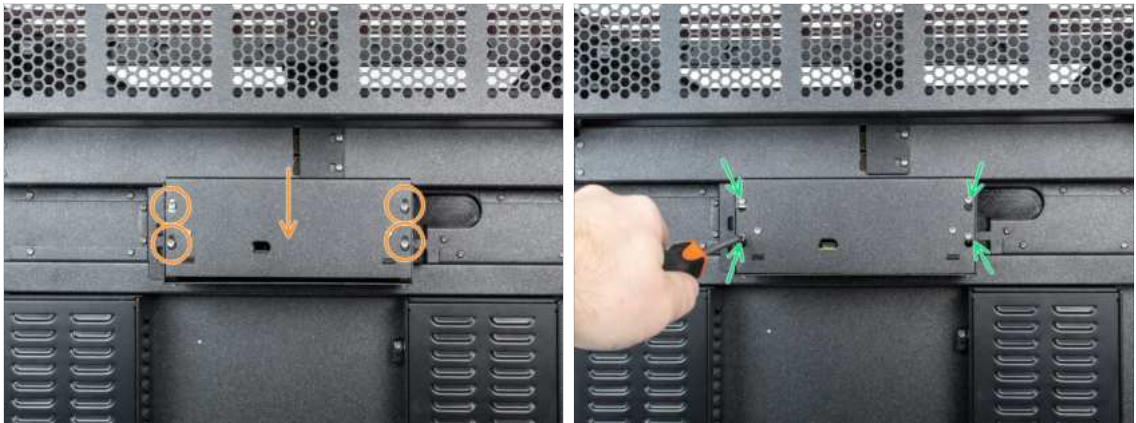

- Attach the XL buddy box cover to the screws on the electronics box. And slide it down to lock it on the screws.
- Tighten the screws with a T10 screwdriver.

## STEP 45 Installing the extrusion covers: parts preparation



- **For the following steps, please prepare:**
  - Extrusion cover 95 mm (4x)
  - Extrusion cover 243 mm (2x)
  - Extrusion cover 390 mm (2x)
  - Extrusion cover 405 mm (1x)
  - Extrusion cover 430 mm (1x)

## STEP 46 Installing front extrusion covers



- Turn the printer's front-right side towards you.
- Take the extrusion cover (243 mm).
- First, insert both ends of the cover into the extrusion.
- Now push the extrusion cover towards the center of the extrusion.
- ⓘ Repeat the process of inserting extrusion covers into the extrusions.
- Insert the extrusion cover (430 mm) into the extrusion.
- Insert the extrusion covers (243 mm) into the extrusions on the left and right sides.
- Insert the orange extrusion covers into the extrusions on the left and right sides.

## STEP 47 Installing rear extrusion covers

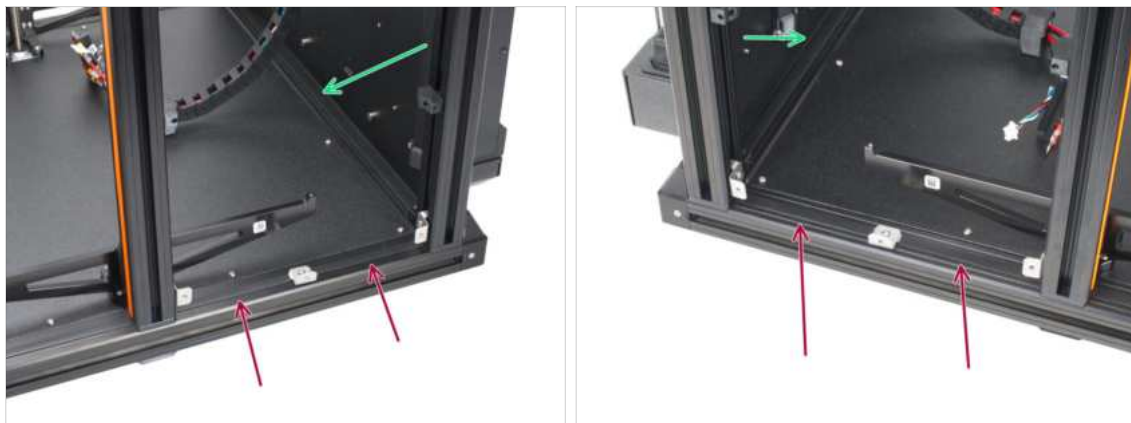

- While inserting the extrusion cover, first insert both ends of the cover, then push it towards the center of the frame.
- Insert the extrusion covers (95 mm) into the extrusion on the left and right sides.
- Insert the extrusion cover (405 mm) into the extrusion.

### STEP 48 Haribo time!



- ◆ Eat another one gummy bear. Yes, just one.
- ⓘ **Did you know that** today, gummy bears are available in a wide range of flavors, including sour, tropical, and exotic fruit varieties?

---

### STEP 49 Good job!



- ◆ **Well done!** You just finished the CoreXY & Back assembly.
- ◆ Now, go to the next chapter **4. Heatbed & Side panels assembly.**



## 4. Heatbed & Side panels assembly



## STEP 1 Tools necessary for this chapter



- For this chapter, please prepare:
  - T10 screwdriver
  - 2.5mm Allen key
  - Phillips PH2 screwdriver

## STEP 2 Side panels preparation



- For the following steps, please prepare:

- Side panel (2x)
- M3x8T screw (20x)

**i** The side panels are symmetrical, it doesn't matter which one you use first.

### STEP 3 Left side panel assembly (part 1)



- ◆ Turn the left side of the printer towards you.
- ◆ Add the side panel onto the printer's frame.
- ◆ Align all cover-clips with the openings on the side panel.

### STEP 4 Left side panel assembly (part 2)



- ◆ Insert M3x8rT screws into all the openings. Before you start tightening them fully, ensure all edges of the panel are properly aligned. Then, tighten up all the screws using the T10 screwdriver.
- ⓘ You can use 1.5mm Allen key inside the openings to adjust the cover-clips alignment slightly.
- ◆ Tighten the top metal cover clip to the frame from the inside, using the T10 screwdriver.

## STEP 5 Right side panel assembly



- i Use the same exact technique to attach the side panel on the other side of the printer.
- Turn the right side of the printer towards you.
- Add the side panel onto the printer.
- Insert M3x8rT screws into all the openings. Before you start tightening them fully, ensure all edges of the panel are properly aligned. Then, tighten up all the screws using the T10 screwdriver.
- Tighten the top metal cover clip to the frame from the inside, using the T10 screwdriver.

## STEP 6 Haribo time!



- It's time for another gummy bear. Take it!
- i **Did you know that** in 1981, the Haribo company, which was founded by Hans Riegel, introduced gummy bears to the United States?

## STEP 7 Heatbed assembly preparation



**⚠ ATTENTION:** Make sure your workspace is clean before you start working with the heatbed. Use a soft pad underneath (cloth / cardboard) to avoid scratching the heatbed components.

- Turn the heatbed upside down.
- Undo the four marked screws holding the bed-controller-case.
- Take the cover off.

**⚠ Don't throw the parts away.** You will need them later on!

## STEP 8 Heatbed terminals preparation

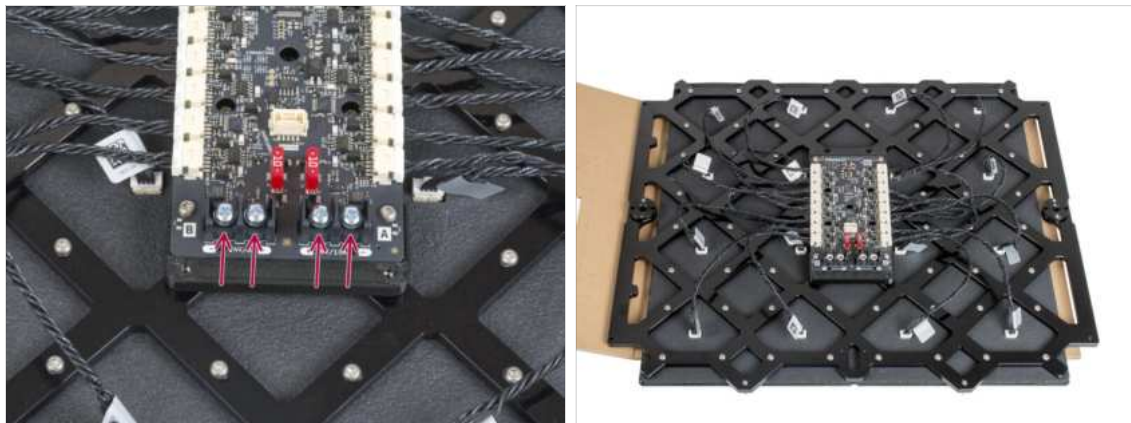

- Remove the four power terminal screws using the Phillips screwdriver. Keep them aside as we will need them in the next step.

## STEP 9 Connecting the Heatbed cables



- ◆ Insert the heatbed into the center of the printer as in the picture with the **terminals facing down**. Keep it in an upright position. Make sure the heatbed cables are accessible below it.
  - ◆ Prepare the power connectors into the indicated layout. **Keep the printed part on.**
    - ◆ **Red (+ / positive)** wires are closer to the center.
    - ◆ **Black (- / negative)** wires are closer to the sides.
  - ◆ Connect the data cable to the center connector.
  - ◆ Attach the power connectors into the terminals and fix them in place using the previously removed screws and the Phillips screwdriver.
- ⚠ **Double check you have connected the power cables correctly!**

## STEP 10 Assembling the Heatbed



- ◆ Re-attach the bed-controller-case.
- ◆ Fix it in place by tightening the four screws using a T10 screwdriver.



## STEP 11 Removing linear rail stoppers



◆ Take off the linear rail stoppers on both inner sides of the printer.

⚠ You might have more than two rail stoppers in both bearings. Pull all of them out from the rail.

## STEP 12 Installing the Heatbed



◆ Take the Heatbed and attach it to the top of the threaded rods. Both of the trapezoid nuts on the sides must engage onto a threaded rod.

⚠ Pay attention to the connected cables while you are attaching the Heatbed!

◆ Using your hand, rotate the threaded rods slightly until both of the rods engage into the nut on the side of the Heatbed.

## STEP 13 Attaching the Heatbed



- ◆ The Heatbed should now hold onto the threaded rods.
- ◆ By rotating the threaded rods on both sides, move the Heatbed approximately 5cm below the top of the threaded rods.
- ⚠ Make sure the Heatbed is always as leveled as possible while you are moving it by rotating the threaded rods with your hand.

## STEP 14 Preparing the Z-Axis bearing housing



- ◆ For the following steps, please prepare:
  - ◆ Z-Axis bearing housing (2x)
  - ◆ Bearing (2x)
  - ◆ M3x10 screw (4x)
- ◆ Slide both bearings into the Z-Axis bearing housings.



## STEP 15 Installing the Z-Axis bearing housing



- Move the HB M3nEs nuts towards the linear rail on both sides of the printer.
- Install the Z-Axis bearing housing onto the M3nEs nuts.
- Insert two M3x10 screws and tighten them using the 2.5mm Allen key.
- ⓘ Repeat the same process for the other side too.

## STEP 16 Preparing the Heatbed screws

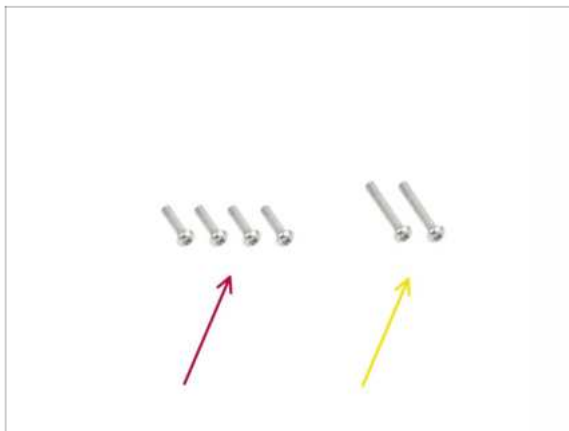

- **For the following steps, please prepare:**
  - M3x12rT screw (4x)
  - M3x20rT screw (2x)

## STEP 17 Fixing the Z-axis side parts in place



- Take the left Z-axis part and slide it up to the heatbed frame.
- Fix it to the heatbed frame with two M3x12rT screws using the T10 screwdriver. Don't tighten it all the way yet!
- Now, fix the **right** Z-axis part to the heatbed frame using the same technique.
- Now, tighten all four screws in a cross pattern:
  - First, tighten the front right and rear left screws.
  - Then, tighten the front left and rear right screws.

## STEP 18 Fixing the heatbed cables



- Take a look inside the printer. We have to attach the cable chain onto the bottom of the heatbed.
- Locate the openings for the cable chain on the back of the heatbed frame.
- Attach the cable chain mount to the openings using two M3x20rT screws. Bend the cables slightly if needed.
- Tighten up the screws using the T10 screwdriver.

### STEP 19 Haribo time!



- ◆ Take two gummy bears. Finally!
- ⓘ **Did you know that** gummy bears have become a popular ingredient in various desserts, including cakes, ice creams, and even cocktails?

---

### STEP 20 Good job!



- ◆ Well done! You have just finished the Heatbed & Side panel assembly.
- ◆ Proceed to the next chapter: **5. Extruder & accessories assembly.**

## 5. Extruder & accessories assembly



## STEP 1 Tools necessary for this chapter

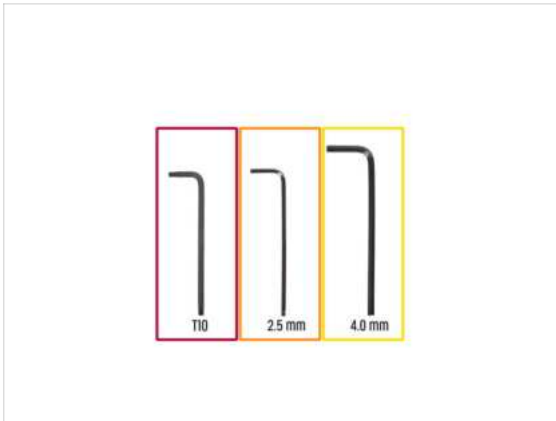

● **For this chapter, please prepare:**

● T10 Torx key

● 2.5 mm Allen key

● 4.0 mm Allen key

● A cardboard box is to be used as heatbed protection during the setup. *Hint: you can use the Nextruder box shipped with your printer.*

## STEP 2 Preparing the X-carriage



- ⚠ **Reminder:** To handle the printer, **always grab the handles on both sides of the printer**. Do not lift the printer by the aluminum extrusions or the metal sheet profiles on top.
- 📘 In the following steps, we will work with tools and install extruder above the heatbed, it is recommended to protect it against any possible damage. An empty Prusament box can serve this purpose.
- ⬛ For better access to the X-carriager in the following steps, manually move the heatbed down.
- 🟡 Attach the print sheet by **first aligning the rear cutout** with the locking pins on the back of the heated bed. Hold the sheet by the front two cutouts and slowly lay it down onto the heated bed - **watch your fingers!**
- 🟢 Place the empty cardboard box approximately to the front center part of the heatbed.
- 🟣 Move the X-axis assembly all the way to the front side of the printer.
- 🟠 Move the X-carriage approximately to the center of the X-axis.

## STEP 3 Installing the ToolChanger: parts preparation

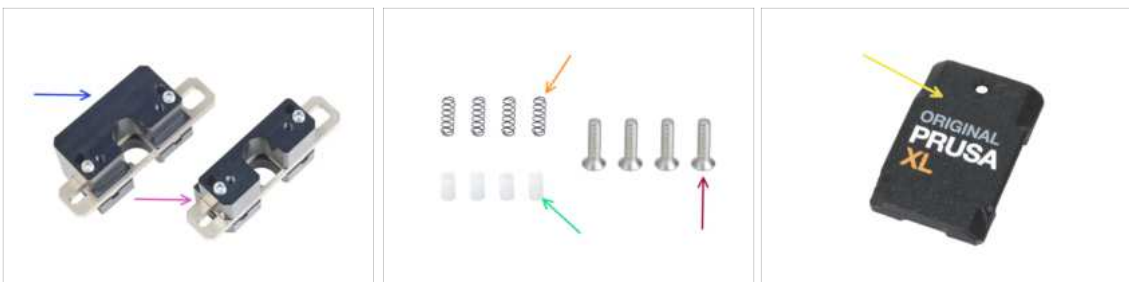

- ⬛ **For the following steps, please prepare:**
- 🟡 Tool Changer Upper Lock (1x)
- 🟣 Tool Changer Lower Lock (1x)
- 🟠 Filament sensor spring A3 (4x)
- 🟢 Push pin (4x)
- 🟤 M3x12cT screw (4x)
- 🟠 X-carriage-cover (1x)

## STEP 4 Preparing the ToolChanger



- 🟠 Insert each Push pin into the holes in both metal parts.
  - 🟡 Insert each Filament sensor spring A3 into the same holes as a Push pins.
  - 🟢 The tool changer is prepared. **The springs must be sticking out.**
- ⚠️ **Be careful that the springs and pins do not fall out when handling the parts.**

## STEP 5 Installing the ToolChanger



- ⚠️ **Be careful that the springs and pins do not fall out when handling the parts.**
- 🟢 Line up the screws in the Tool Changer Lower Lock assembly with the blind holes in the X-carriage. **See the correct orientation of the part.** Use the U-shaped groove in the part.
  - ⬛ Take a look at the X-carriage from the rear side.
  - 🟡 Attach the Tool Changer Lower Lock assembly to the X-carriage and secure it with two M3x12cT screws from the front side. Ensure the correct orientation of the part.
  - 🟣 Attach the Tool Changer Upper Lock assembly to the X-carriage from the top and secure it with two M3x12cT screws from the front side.

## STEP 6 Covering the X-carriage

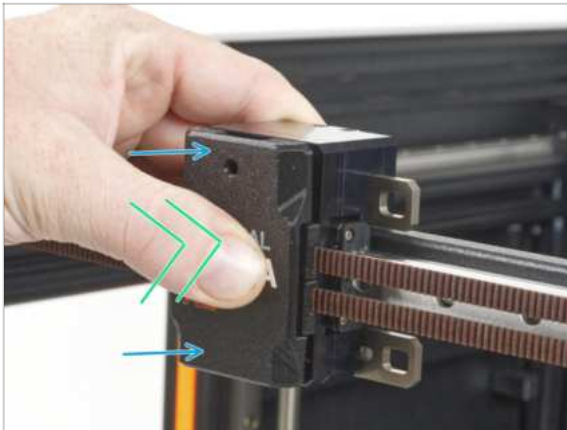

- Attach the x-carriage-cover on the X-carriage with the hole up.
- Push the center of the cover using your thumb. The cover will then snap into the latches on the X-carriage. You will feel a light "click" when it is successfully snapping.

## STEP 7 Preparing the Filament sensor



- For the following steps, please prepare:
  - M3x12rT screw (1x)
  - M3nEs nut (1x)
  - Filament sensor assembly
- Turn the printer around so that its left side is facing you.
- Insert the M3nEs nut into the vertical extrusion on the rear of the left side.



## STEP 8 Attaching the filament sensor



- Connect the filament sensor cable into the filament sensor assembly.
- Move the filament sensor assembly to the top of the extrusion and align the M3nEs nut so that it aligns with the opening on the filament sensor assembly.
- Attach the filament sensor to the M3nEs nut using the M3x12rT screw and T10 screwdriver.

## STEP 9 Nextruder assembly: parts preparation

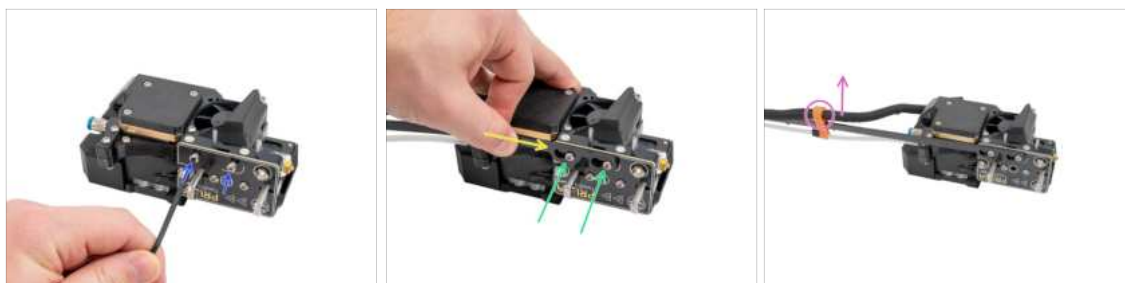

- For the Nextruder cable bundle assembly please prepare:
  - Nextruder (2x)
  - Cable bundle (2x)

**STEP 10** Nextruder cable bundle assembly

◆ Repeat this step for both tool heads:

- ◆ Using the T10 key, loosen the marked two screws on the inside of the Nextruder.
- ◆ Hook up the keyhole openings in the flexible plate of the cable bundle onto the screw heads.
- ◆ Using a T10 key tighten the marked two screws.
- ◆ Make sure the part of the bundle with the cable and the connector is facing the top of the Nextruder; as seen in the picture.

⚠ The cable bundle must be installed exactly the same way as in the picture; with the cable on top and the semi-transparent PTFE tube on the bottom.

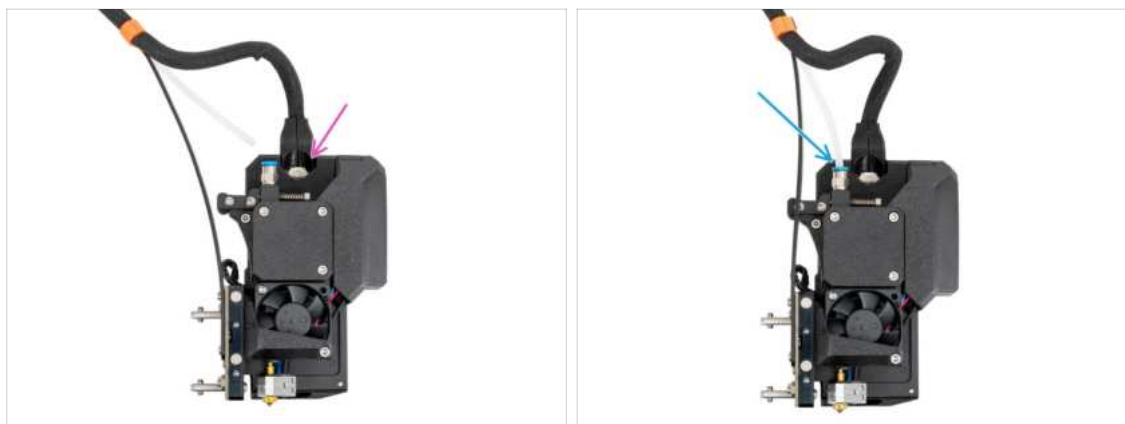
**STEP 11** Nextruder cable bundle assembly

◆ Repeat this step for both tool heads:

- ◆ Attach the cable connector into the top of the Nextruder.
- ◆ Insert the semi-transparent PTFE tube into the fitting QSM-M5 on the Nextruder.

ⓘ Starting from September 2024, you may receive a new black Fitting M5-4. The assembly and functionality remain identical to the blue one.

## STEP 12 Nextruder dock preparing



- ◆ The latest assemblies come with the nozzle seal pre-installed on the extruder dock. To confirm this, examine one of the extruder docks closely and compare it to the picture to see if the nozzle seal is already in place with the square nut. **If not, continue with the text below.**
- ◆ **Repeat this step for both tool heads:**
  - Check that the M3nS nut is inserted in the Nextruder dock.
  - Make sure the nut is pushed into the dock all the way. If not use the Allen key to push the nut into the Nextruder dock.





## STEP 13 Guiding the first Nextruder cable



- ◆ Carefully turn the printer 180° so that the PSU (Power Supply Unit) side is towards facing you.
  - ◆ Locate the long metal profile with five M3 holes inside the rear aluminum extrusion and slide it all the way to the left side.
  - ◆ We'll use the first two M3 holes in the metal profile.
  - ◆ Place the first Nextruder on a box and guide the cables on the back side of the printer.
- ⚠ **The nextruder can move when handling the cabling. Keep watching the Nextruder!**



## STEP 14 Attaching the first Nextruder dock



-  Check the position of the long metal profile, it must be positioned on the far left.
-  Place the xl-dock-cable-router on the bottom metal sheet below the aluminum extrusion.
-  There is a protruding screw from the xl-dock-cable-router. Attach the screw to the first screw hole on the long metal profile. Through the hole in the rear metal sheet, check if the cable holder is lined up with the hole.
-  Push the 2.5 mm Allen key all the way through the hole in the rear metal sheet until you reach the **middle** screw in the xl-dock-cable-router and tighten the screw.
-  **The dock is a press fit, so the screw needs to be tightened very hard.**

## STEP 15 Dock inspection



-  Check that the docks are properly tightened. **The dock must not move.**
-  The dock is a press fit, so the screw needs to be tightened very hard.
-  Please watch the video in the next step for a better understanding.

## STEP 16 Dock inspection: video



- ◆ The following instructions need to be done correctly and carefully. Achieve better understanding and successful assembly by watching the video alongside the guide.

## STEP 17 Nozzle seal: parts preparation



- ⓘ Starting from May 2024, you may receive a gray nozzle seal. The assembly and functionality remain identical to the red one.
- ◆ **For the following steps, please prepare:**
  - Nozzle seal (2x)
  - Spring 15x5 (2x)
- ⓘ If you have a newer version of the xl-dock-cable-router that already has the nozzle seal installed, please skip to step **First Nextruder docking**.

## STEP 18 Assembling the Nozzle seal

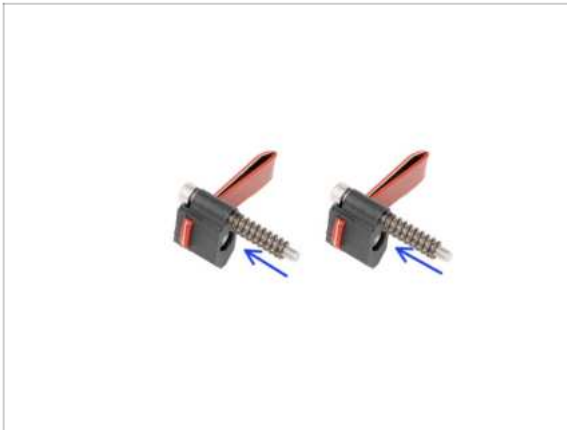

- ◆ Slide the spring on each nozzle seal.

## STEP 19 Nextruder nozzle seal



- ⓘ **The current nozzle seal position is temporary, the exact height will be set in the next chapter** once all the Nextruder parts are mounted.
- Insert the nozzle seal (with the spring) into the dock.
- Using a 2.5 mm Allen key, tighten the screw so that the head of the screw is 1 mm above the dock.
- Good! The first dock is ready.



## STEP 20 First nextruder docking

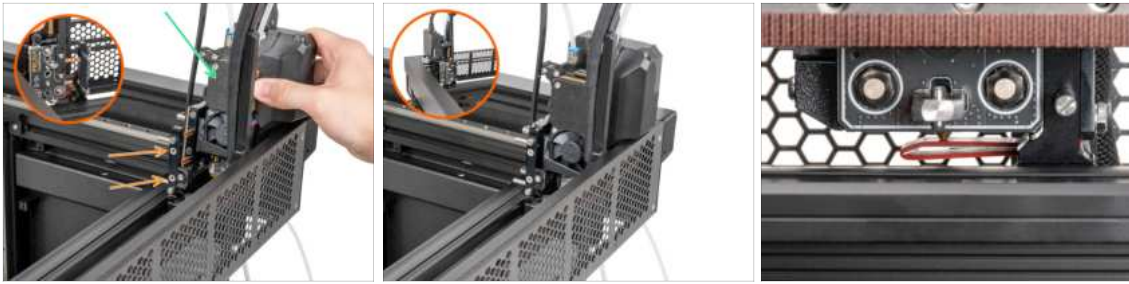

- ◆ Take the Nextruder and place it carefully next to the dock.
- ◆ Place the two metal inserts through the white holes in the dock. The magnets will help you dock the Nextruder.
- ⓘ Check that the Nozzle seal lightly touches the nozzle.
- ◆ Well done, the first Nextruder is ready!

## STEP 21 Guiding the second Nextruder cable



- ◆ Place the second Nextruder on a box and guide the cables on the back side of the printer.
- ◆ Place the xl-dock-cable-router on the bottom metal sheet below the aluminum extrusion.
- ◆ There is a protruding screw from the xl-dock-cable-router. Attach the screw to the second screw hole on the long metal profile. Through the hole in the rear metal sheet, check if the cable holder is lined up with the hole.
- ◆ Push the 2.5 mm Allen key all the way through the hole in the rear metal sheet until you reach the **middle** screw in the xl-dock-cable-router and tighten the screw.
- ⓘ **The dock is a press fit, so the screw needs to be tightened very hard.**



## STEP 22 Dock inspection

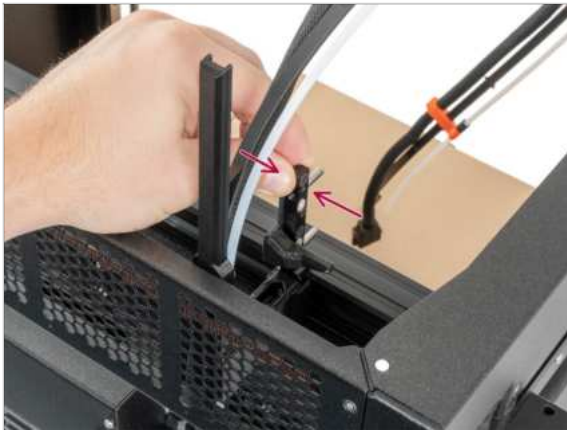

- ⚠ Check that the docks are properly tightened. **The dock must not move.**
- ℹ The dock is a press fit, so the screw needs to be tightened very hard.
- ◆ Please watch the video in the next step for a better understanding.

---

## STEP 23 Dock inspection: video

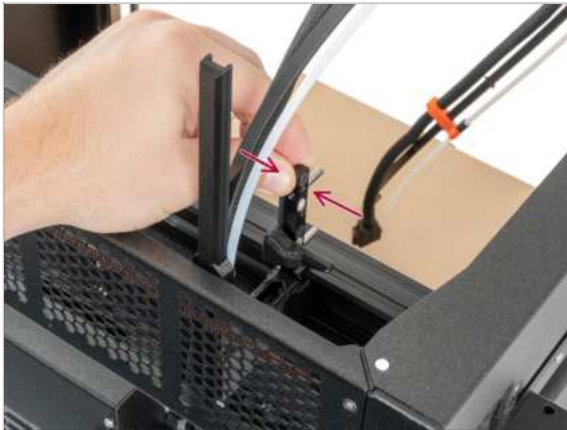

- ◆ The following instructions need to be done correctly and carefully. Achieve better understanding and successful assembly by watching the video alongside the guide. Watch this [prusa.io/XL-dock-installation](https://prusa.io/XL-dock-installation).

## STEP 24 Nextruder nozzle seal



- The current nozzle seal position is temporary, the exact height will be set in the next chapter once all the Nextruder parts are mounted.
- Insert the nozzle seal (with the spring) into the dock.
- Using a 2.5 mm Allen key, tighten the screw so that the head of the screw is 1 mm above the dock.
- Good! The second dock is ready.

## STEP 25 Second Nextruder docking



- Carefully turn the printer so that the front side is facing towards you.
- Take the Nextruder and place it carefully next to the dock.
- Place the two metal inserts through the white holes in the dock. The magnets will help you dock the Nextruder.
- ⓘ Check that the Nozzle seal lightly touches the nozzle.
- Well done, the second Nextruder is ready!

## STEP 26 Guiding the extruder PTFE tube

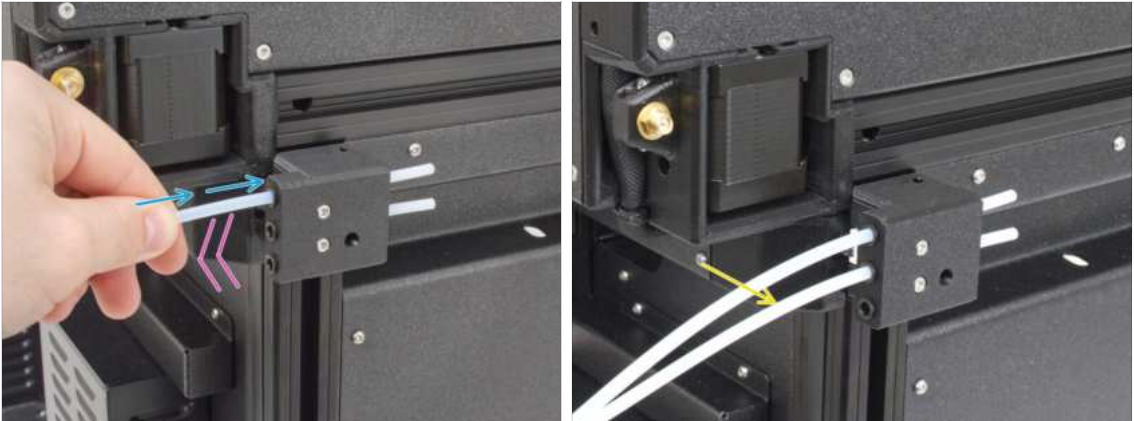

- There is a side filament sensor on the side of the printer. Insert the first Nextruder PTFE tube all the way into the upper hole in the part.
- Gently pull the PTFE tube back, this will push out the black collet in the side filament sensor and lock the tube.
- Repeat this process for the second Nextruder PTFE tube.

## STEP 27 Wi-fi antenna holder versions



- The antenna connector is prepared by the manufacturer:
  - Version A: The Wi-fi antenna holder is on the side
- The antenna connector has to be assembled by you:
  - Version B: The Wi-fi antenna is in the middle. Please skip to **Version B: Connecting the Nextruder cables.**

## STEP 28 Version A: Connecting the Nextruder cables



- Locate the xl-rear-cable-management-plug (cover) on the rear of the printer.
- Loosen two screws on the cover slightly. No need to remove them completely. Push the cover to the right and remove it from the printer.
- Connect the second Nextruder cable to the lower slot labeled DWARF 2.
- Connect the first Nextruder cable to the upper slot labeled DWARF 1.
- Attach the connectors cover to the screws. Push it all the way to the right and tighten the screws.

## STEP 29 Version A: Installing the Wi-Fi antenna: parts preparation



- For the following steps, please prepare:
- Wi-Fi antenna (1x)
  - ⓘ The Original Prusa XL might be shipped with one of the two versions of the Wi-Fi antenna. Each has a different shape. Both work the same.



### STEP 30 Version A: Installing the Wi-Fi antenna



- ◆ Locate the Wi-Fi antenna connector on the left rear corner of the printer.
- ◆ Screw the antenna onto the connector.
- ⓘ The antenna can be rotated and bent in two directions.
- ◆ We recommend pointing the antenna straight up.

### STEP 31 Version B: Connecting the Nextruder cables

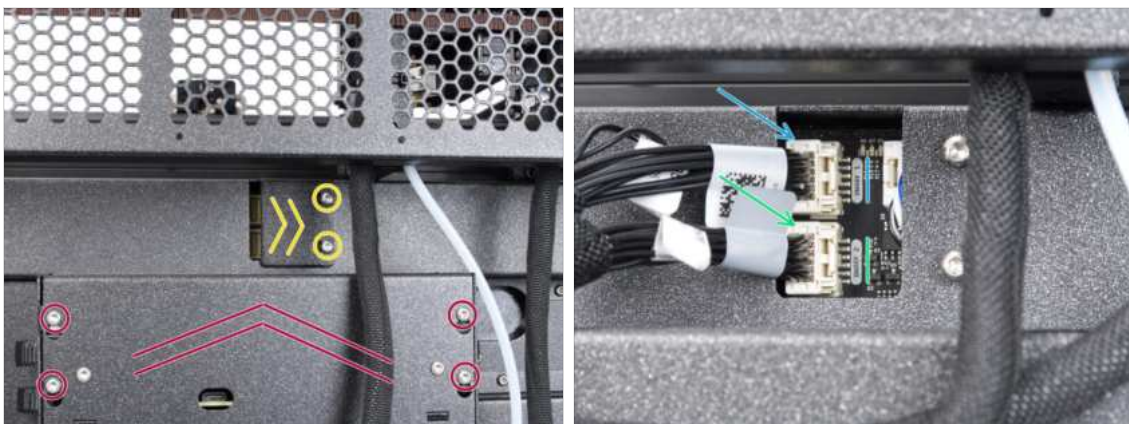

- ◆ Locate the xl-rear-cable-management-plug (cover) on the rear of the printer.
- ◆ Loosen two screws on the cover slightly. No need to remove them completely. Push the cover to the right and remove it from the printer.
- ◆ Loosen four screws securing the electronics cover. Remove the cover.
- ◆ Connect the second Nextruder cable to the lower slot labeled DWARF 2.
- ◆ Connect the first Nextruder cable to the upper slot labeled DWARF 1.

## STEP 32 Version B: Wi-Fi antenna holder: parts preparation



- For the following steps, please prepare:
- Wi-Fi-antenna-holder version E3/E4 (1x)
- Antenna cable (1x)

## STEP 33 Version B: Installing the Wi-Fi antenna: antenna preparing



- Remove the nut with the washers from the antenna connector.
- The antenna connector is prepared.
- The latest version of the connector has a thicker washer. We don't need it anymore. You can throw it away.
- Insert the antenna connector into the same-shaped hole in the Wi-Fi-antenna-holder .

### STEP 34 Version B: Installing the Wi-Fi antenna: antenna preparing

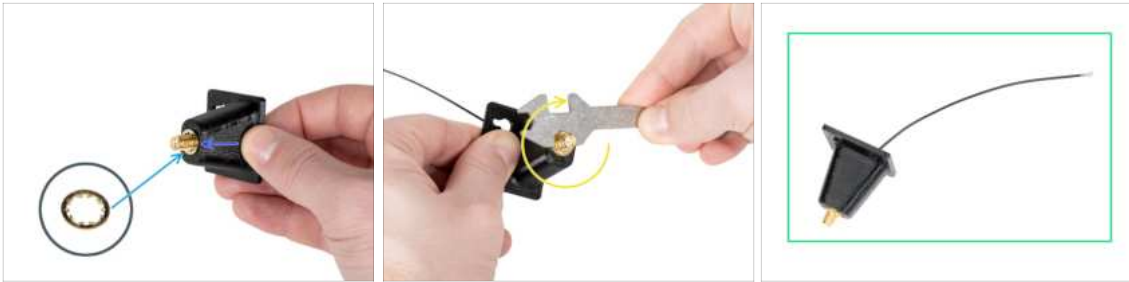

- Push the antenna connector through the Wi-Fi-antenna-holder.
- Insert the thinner washer back onto the connector.
- Using the universal wrench, tighten the nut on an antenna connector.
- Good job! The Wi-Fi antenna is prepared.

### STEP 35 Version B: Installing the Wi-Fi antenna holder



- Push the antenna cable through the opening in the cable cover (metal sheet) and guide it behind the cover to the electronics box.
- Attach the antenna-holder on the screws and push the cover to the left and tighten the screws.
- Connect the antenna cable with the antenna connector on the XL buddy board. Support the Wifi board with your finger while attaching the cable.



### STEP 36 Version B: XL buddy box covering

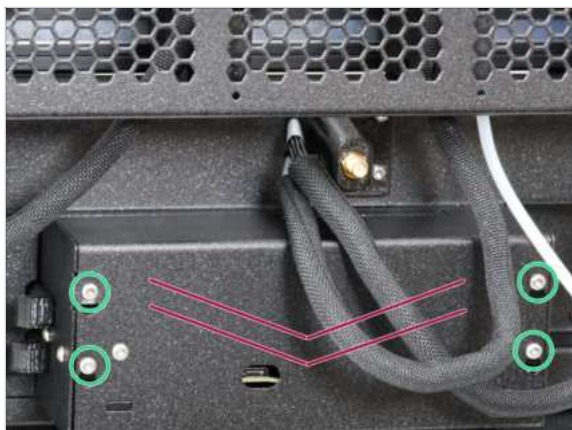

**⚠ Be careful, do not pinch any cables!**

- ➡ Put the XL-buddy-box-cover back on the printer.
- ➡ With a T10 key tighten the four screws.

### STEP 37 Version B: Installing the Wi-Fi antenna: parts preparation



➡ **For the following steps, please prepare:**

- ➡ Wi-Fi antenna (1x)
- i** The Original Prusa XL is shipped with two versions of the Wi-Fi antenna, each with a different shape. The functionality is the same.

### STEP 38 Version B: Installing the Wi-Fi antenna



- ➡ Locate the Wi-Fi antenna connector in the middle of the printer.
- ➡ Screw the Wi-Fi antenna on the antenna connector. The antenna can be rotated around and bent in two directions.
- ➡ We recommend pointing the antenna straight upwards.

### STEP 39 Haribo time!



◆ **Take three gummy bears** and share the rest of the gummy bears with the people who helped you build the 3D printer.

ⓘ **Did you know that** gummy bears are loved by people of all ages, from children to adults, and are often enjoyed as a nostalgic treat?

### STEP 40 Spoolholder assembly versions



ⓘ **Original Prusa XL comes with two versions of the spool holder.** Each version has slightly different parts and different procedures.

◆ **Refer to the pictures to compare which parts you have, and then choose the instructions that match:**

◆ **Printed spool holder (Version A):** Set of three printed parts. If you have this version, continue to the **Version A: Assembling the spool holder: parts preparation**

◆ **Injection molded spool holder (Version B):** Set of two injection molded parts. If you have this version, continue to **Version B: Assembling the spool holder: parts preparation**

## STEP 41 Version A: Assembling the spool holder: parts preparation



● For the following steps, please prepare:

- Spool-holder-slider (2x)
- Spool-holder-base (2x)
- Spool-holder-mount (2x)
- M5x85 screw (2x)
- M5nEs nut (2x)

## STEP 42 Version A: Assembling the spool holder: adjusting the nut



- Carefully turn the printer so that the side with the Wi-Fi antenna and side filament sensor faces you.
- Insert the M5nEs nut into the front support extrusion (with the orange plastic cover). Insert the side with the spring (metal plate) first, then push the nut inside.
- The M5nEs nut is free to move, you can adjust the position as you want. But remember, the nut must be slightly pushed in to smoothly move. Anyway, we recommend approximately the same position as you can see in the picture.
- Insert the second M5nEs nut in the extrusion approximately to the same position as shown.

### STEP 43 Version A: Assembling the spool holder



◆ Repeat this step for both spool holders:

- ◆ Insert the spool-holder-base into the spool-holder-slider and push it through a little through the part.
- ◆ Attach the spool-holder to the spool-holder-mount.
- ◆ Insert the M5x85 screw into the spool-holder-assembly.

### STEP 44 Version A: Mounting the spool holder assembly



- ◆ Attach the spool holder assembly to the M5nEs nut in the extrusion. Note that there is a protrusion on the spool-holder-mount, which must fit into the groove in the extrusion.
- ◆ Tighten the spool holder assembly.
- ⚠ **Do not use the spool holder as a handle!**
- ⓘ Keep in mind that if you mount the Spool holder too high or too low, it may not fit the filament spool on it. There has to be enough space around it.

**STEP 45** Version B: Assembling the spool holder: parts preparation

- For the following steps, please prepare:
- Spool-holder-slider (2x)
- Spool-holder-base (2x)
- M4x12 screw (2x)
- M4nEs nut (2x)

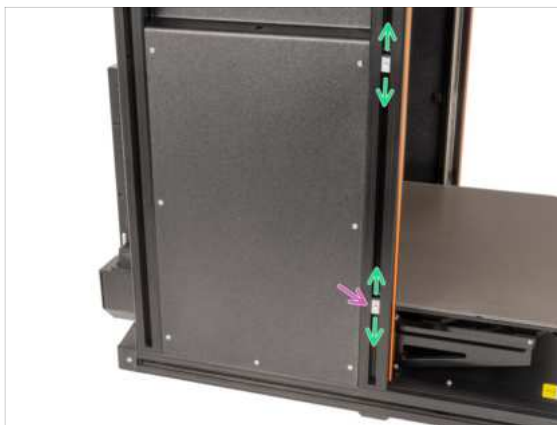
**STEP 46** Version B: Assembling the spool holder: adjusting the nut

- Carefully turn the printer so that the side with the side filament sensor is facing you.
- Insert the M4nEs nut into the front support extrusion (with the orange plastic cover). Insert the side with the spring (metal plate) first, then push the nut inside.
- Insert the second M4nEs nut.
- The M4nEs nut is free to move, you can adjust the position as you want. But remember, the nut must be slightly pushed in to smoothly move. Anyway, we recommend approximately the same position as you can see in the picture.
- ⓘ Keep in mind that if you mount the Spool holder too high or too low, it may not fit the filament spool on it. There has to be enough space around it.

## STEP 47 Version B: Assembling the spool holder



- Locate pins two pins on the spool-holder-base and line them with the rails in the spool-holder-slider.
- Insert the spool-holder-base into the spool-holder-slider and push it through a little through the part.

## STEP 48 Version B: Preparing the spool holder



- Insert the M4x12 screw on the longer side of the 3mm Allen key.
- Insert the 3mm Allen key with the M4x12 screw through the assembled spool holder to the prepared hole in the spool-holder-base.
- The M4x12 screw has to protrude through the spool-holder-base.



## STEP 49 Version B: Mounting the spool holder assembly



- Attach the spool holder assembly to the M4nEs nut in the extrusion. Note that there is a protrusion on the spool-holder-mount, which must fit into the groove in the extrusion.
- Tighten the first spool holder assembly.
- Assemble the second spool holder and attach it to the lower M4nEs nut with an M4x12 screw.

 **Do not use the spool holder as a handle!**

## STEP 50 Almost done!



- **Congratulation!** Your Original Prusa XL is ready to be fired up!
- Compare the final look with the picture.
- Now, let's go to the last chapter **First run.**



# Manual changelog XL Dual-Head (Semi-Assembled)



## STEP 1 Version history



- ◆ **Versions of the Original Prusa XL semi-assembled (Dual-head) manual:**
- ◆ 06/2023 - Initial version 1.00
- ◆ 07/2023 - Updated to version 1.02
- ◆ 08/2023 - Updated to version 1.03
- ◆ 11/2023 - Updated to version 1.04
- ◆ 05/2024 - Updated to version 1.05
- ◆ 09/2024 - Updated to version 1.06

## STEP 2 Changes to the manual (1)

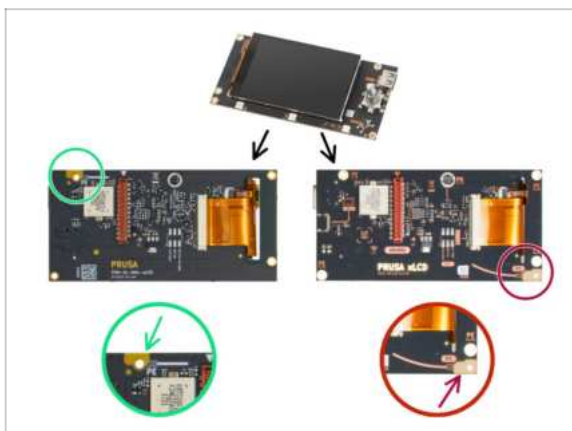

- ◆ 07/2023 - xLCD assembly
- ◆ Added instructions for the new xLCD.
- ⓘ Manual version 1.01

---

### STEP 3 Changes to the manual (2)

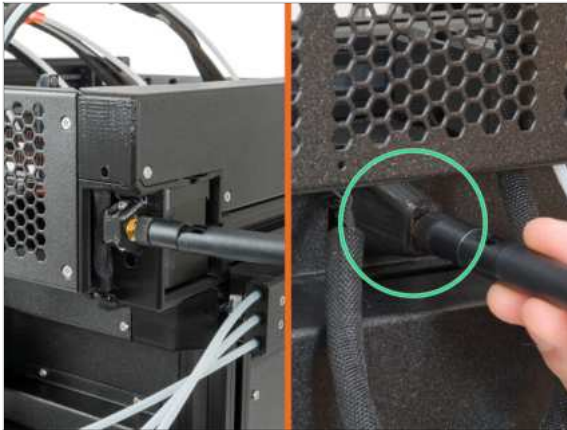

- 08/2023 - Antenna adapter
- Added instructions for the new antenna adapter.
- Manual version 1.02

---

### STEP 4 Changes to the manual (3)

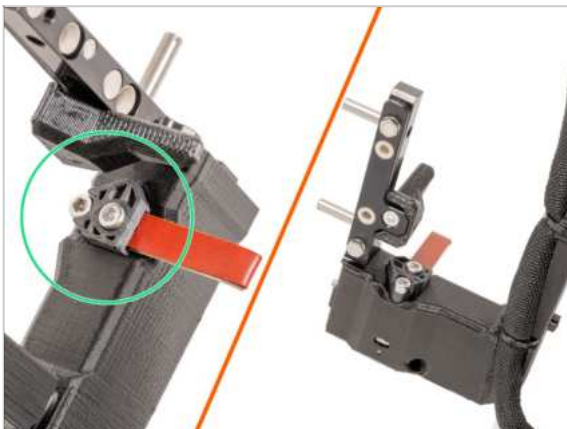

- 08/2023 - Nextruder dock
- Added instructions for the new dock.
- Manual version 1.03

---

## STEP 5 Changes to the manual (4)



- 11/2023 - Spoolholder
  - Added instructions for the new injection molded Spoolholder.
- Manual version 1.04

---

## STEP 6 Changes to the manual (5)



- 05/2024
  - Added information about the new gray nozzle seal.
- Manual version 1.05

## STEP 7 Changes to the manual (6)



- 09/2024 - xLCD
  - Added instructions for the new injection molded xLCD.
- Manual version 1.06













