

Table of Contents

1. Introduction	5
Step 1 - General information	6
Step 2 - What awaits you during the unpacking	6
Step 3 - Tools in the package	7
Step 4 - Labels guide	7
Step 5 - Cheatsheet	8
Step 6 - Silicone sock	8
Step 7 - CAUTION: Lubricant Handling	9
Step 8 - View high resolution images	9
Step 9 - We are here for you!	10
2. Printer unboxing	11
Step 1 - Introduction	12
Step 2 - Opening the package	12
Step 3 - Opening the package	13
Step 4 - Removing the inserts	13
Step 5 - Removing the inserts	14
Step 6 - Removing the inserts	14
Step 7 - Unpacking the printer	15
Step 8 - Printer is ready for setup	15
3. Printer set up	16
Step 1 - Tools necessary for this chapter	17
Step 2 - Injection molded xLCD: parts preparation	17
Step 3 - Injection molded xLCD: xLCD cables	18
Step 4 - Injection molded xLCD: mounting the xLCD	18
Step 5 - xLCD: parts preparation	19
Step 6 - Mounting the xLCD	19
Step 7 - Mounting the xLCD	20
Step 8 - Preparing the printer	20
Step 9 - Nextruder cable: parts preparation	21
Step 10 - Preparing the Nextruder dock	21
Step 11 - Guiding the nextruder cable	22
Step 12 - Attaching the first and second nextruder dock	23
Step 13 - Dock inspection	23
Step 14 - Dock inspection: video	24
Step 15 - Third dock: screw removing	24
Step 16 - Nozzle seal: parts preparation	25
Step 17 - Assembling the Nozzle seal	25
Step 18 - Installing the nextruder nozzle seal	26
Step 19 - Wi-Fi antenna holder versions	27
Step 20 - Version A: Connecting the nextruder cables	28
Step 21 - Version A: Removing the XL buddy box cover	28
Step 22 - Version A: Connecting the Nextruder cables	29
Step 23 - Version A: Covering the XL buddy box	29
Step 24 - Version A: Guiding the PTFE tubes	30
Step 25 - Version A: Guiding the docks PTFE tubes	30
Step 26 - Version A: Installing the Wi-Fi antenna: parts preparation	31
Step 27 - Version A: Installing the Wi-Fi antenna	31
Step 28 - Version B: Wi-Fi antenna holder: parts preparation	32
Step 29 - Version B: Installing the Wi-Fi antenna: antenna preparing	32
Step 30 - Version B: Installing the Wi-Fi antenna: antenna preparing	33

Step 31 - Version B: Connecting the nextruder cables	33
Step 32 - Version B: Installing the Wi-Fi antenna holder	34
Step 33 - Version B: Connecting the Nextruder cables	34
Step 34 - Version B: XL buddy box covering	35
Step 35 - Version B: Guiding the docks PTFE tubes	35
Step 36 - Version B: Guiding the PTFE tubes	36
Step 37 - Version B: Installing the Wi-Fi antenna: parts preparation	36
Step 38 - Version B: Installing the Wi-Fi antenna	37
Step 39 - Spool holder assembly versions	37
Step 40 - Version A: Spool holder: parts preparation	38
Step 41 - Version A: Spool holder: left side	38
Step 42 - Version A: Assembling the spool holder	39
Step 43 - Version A: Mounting the spool holder assembly	39
Step 44 - Version A: Spool holder: right side assembly	40
Step 45 - Version B: Assembling the spool holder: parts preparation	40
Step 46 - Version B: Assembling the spool holder: adjusting the nut	41
Step 47 - Version B: Assembling the spool holder	41
Step 48 - Version B: Preparing the spool holder	42
Step 49 - Version B: Spool holder: left side assembly	42
Step 50 - Version B: Spool holder: right side assembly	43
Step 51 - Nextruder assembly: parts preparation	43
Step 52 - Docking the Nextruder	44
Step 53 - Nextruder cable bundle assembly	44
Step 54 - Nextruder cable bundle assembly	45
Step 55 - Almost done!	45
5. First run	46
Step 1 - Before you start with Multi-Tool	47
Step 2 - Preparing the printer	47
Step 3 - Prusa Nextruder sock (Optional)	48
Step 4 - Nozzle seal height calibration	48
Step 5 - Nozzle seal height calibration	49
Step 6 - Wizard	49
Step 7 - Wizard: Dock Position Calibration	50
Step 8 - Wizard: Loosen pin	50
Step 9 - Wizard: Loosen screws	51
Step 10 - Wizard: Lock the tool	51
Step 11 - Wizard: Tighten the upper screw	52
Step 12 - Wizard: Tighten the lower screw	52
Step 13 - Wizard: Install pins	53
Step 14 - Wizard: Dock successfully calibrated	53
Step 15 - Wizard: Loadcell test	54
Step 16 - Wizard: Calibrate Filament Sensors	54
Step 17 - Wizard: Calibrate Filament Sensors	55
Step 18 - Calibration pin: parts preparing	55
Step 19 - Calibration pin: parts assembly	56
Step 20 - Wizard: Tool Offset Calibration	56
Step 21 - Wizard: Sheet install	57
Step 22 - Wizard: Calibration pin installation	57
Step 23 - Wizard: Offset calibration done	58
Step 24 - Calibration pin	58
Step 25 - It's done	59
Step 26 - Regular printer maintenance	59
Step 27 - Quick guide for your first prints	60
Step 28 - Printable 3D models	60



Step 29 - Prusa knowledge base	61
Step 30 - Join Printables!	61
Manual changelog Five-Head (Assembled)	62
Step 1 - Version history	63
Step 2 - Changes to the manual (1)	63
Step 3 - Changes to the manual (2)	64
Step 4 - Changes to the manual (4)	64
Step 5 - Changes to the manual (5)	65
Step 6 - Changes to the manual (6)	65

1. Introduction



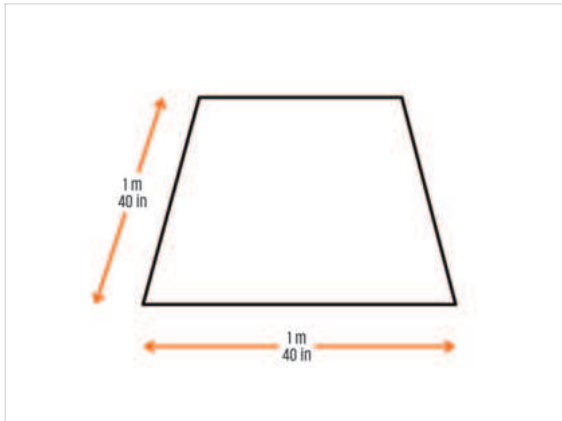





STEP 1 General information

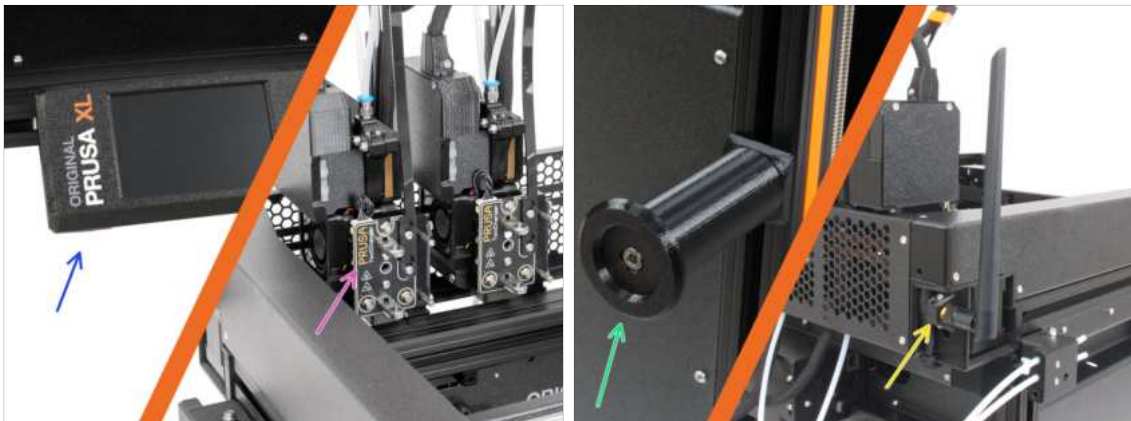

-  **The package with the printer is heavy!** Always ask another person for help with handling.
-  For the assembly, **prepare a clean workbench with a space of at least 1 m x 1 m (40 in x 40 in).**
-  We're recommending a **bright light above your workbench.** Some parts of the printer are dark and inadequate light could make a very difficult procedure.

STEP 2 What awaits you during the unpacking



-  Because of transportation, some of the fragile parts must be safely packed separately in the printer package. This manual will take you through the installation of these parts on the printer.
-  **These parts will be installed:**
 -  xLCD assembly
 -  Multi-Tool nextruder assembly
 -  Spool holder
 -  Wi-Fi antenna

STEP 3 Tools in the package



◆ The package includes:

- ① Some of the tools are intended primarily for regular printer maintenance. You won't need them for this manual. At the beginning of the assembly chapter is a list of the necessary tools.
- Torx key TX6, TX8, TX10
- Allen key 2.5 mm, 4.0 mm
- Wrench 13-16
- Universal wrench
- T10 screwdriver
- Philips PH2 screwdriver
- ◆ **The printer's package contains a lubricant, which is intended for maintenance.** No need to apply it during the assembly. There is a dedicated online manual [Regular printer maintenance](#).

STEP 4 Labels guide



- ◆ All the boxes and bags including parts for the build are labeled.
- The LCD Fasteners bag includes an extra spare of each part contained in the bag. The amount of spare parts is written on the label. This number is included in the total number of each type of part.

STEP 5 Cheatsheet

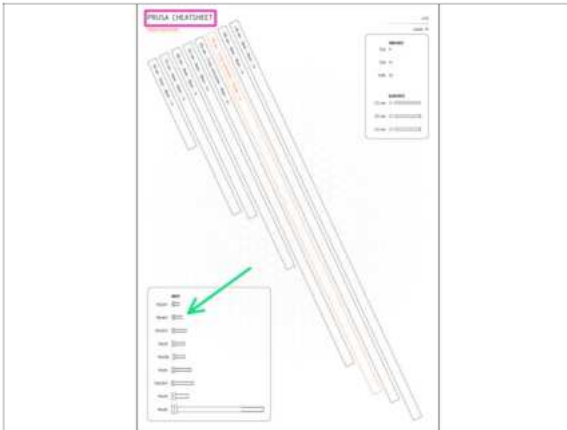

- ◆ Your package contains a letter, on the back of which is a Cheatsheet with drawings of all the necessary fasteners.
- ◆ The fasteners drawings are 1:1 scale, so you can compare the size by placing the fastener on the paper to make sure you are using the correct type.
- ⓘ You can download it from our site prusa.io/cheatsheet-xl. Print it at 100 %, don't rescale it, otherwise, it won't work.

STEP 6 Silicone sock



- ◆ A silicone sock is supplied with each Nextruder package.
- ◆ The main function of a silicone sock is to keep the temperature in the heater block stable, which improves the printer's performance.
- ⓘ Also, it keeps your hotend clean from filament dirt and protects it in case the print detaches from the print surface.
- ◆ You will be asked to install the sock later in this guide.
- ⓘ How to install the sock - [check the article](#).

STEP 7 CAUTION: Lubricant Handling

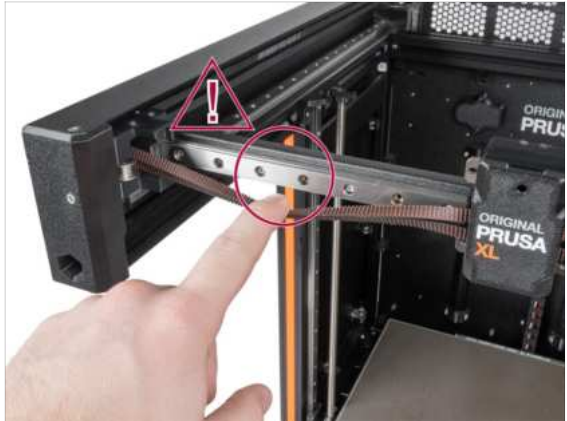
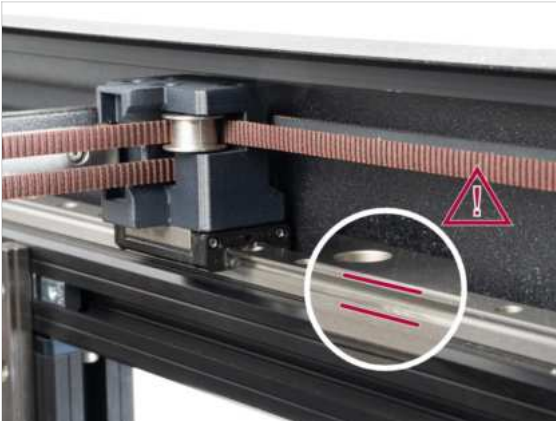

⚠ CAUTION: Avoid direct skin contact with the lubricant used for the linear rails in this printer. If a contact occurs, wash your hands immediately. Especially before eating, drinking, or touching your face.

- Lubricant accumulates in the printer's bearings, mainly in the linear rail channels.

STEP 8 View high resolution images



i When you browse the guide on help.prusa3d.com, you can view the original images in high resolution for clarity.

- ◆ Just hover your cursor over the image and click the Magnifier button ("View original") in the top left corner.

STEP 9 We are here for you!

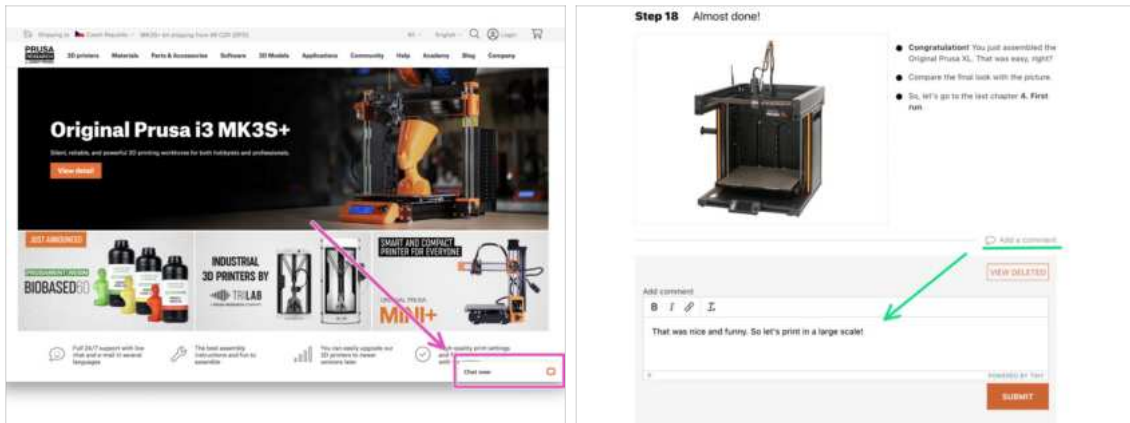



- Lost in the instructions? Missing screw or cracked printed part? **Let us know!**
- You can contact us using following channels:
 - Using comments under each step.
 - Using our 24/7 live chat at shop.prusa3d.com
 - Writing an email to info@prusa3d.com
- Are you ready to get started on the assembly? Let's move on to chapter **2. Printer unboxing.**

2. Printer unboxing







STEP 1 Introduction

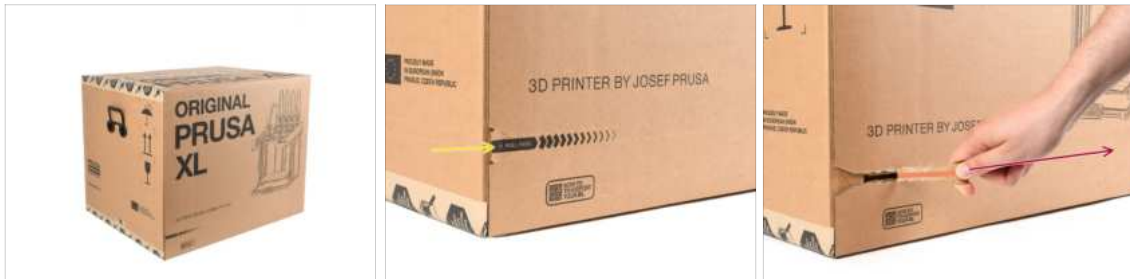

-  **The printer package is heavy!** Ask someone to help you out.
-  **If children are involved, always supervise them to avoid an injury.**
-  **We recommend keeping all the packaging material** in case you decide to send the printer back for service.

STEP 2 Opening the package



-  Place the package on a stable surface. **Make sure the package is oriented top side up.** See the transportation label.
-  The package is equipped with a tear strip that splits the box in two parts.
-  Peel off the entire tear strip to split the box.

STEP 3 Opening the package



● Remove the top part of the box by lifting it up.

⚠ Inside, there are cardboard inserts that contain parts necessary for the assembly. **Do not throw them out!**

STEP 4 Removing the inserts



● Remove the top front cardboard insert. There are parts inside

⚠ **There are printer parts inside the top cardboard insert! Make sure not to lose them!**

● Remove the boxes on the side containing the nexttruder parts.

● Remove the cardboard insert with the Haribos inside and the remaining nexttruder boxes.

STEP 5 Removing the inserts

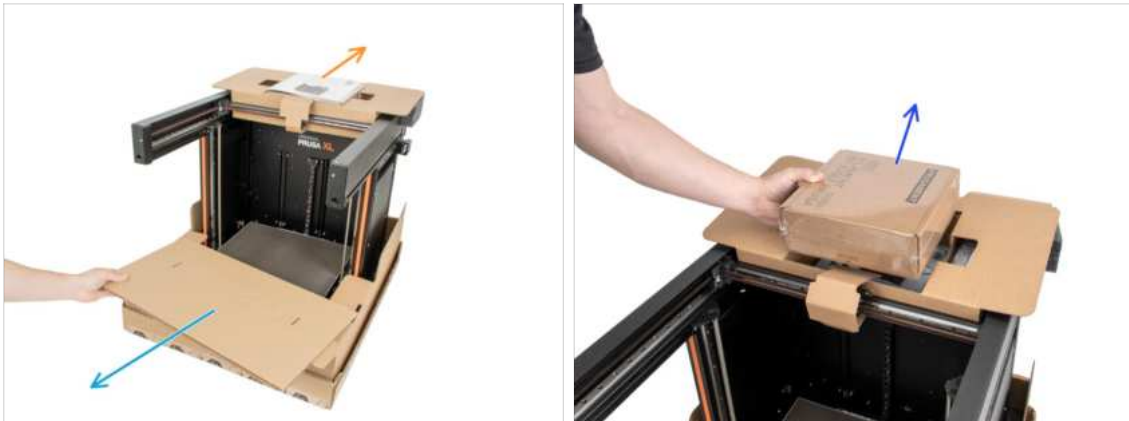

- Remove the front inner insert.
- Remove the welcome letter.
- Remove the box with Prusament on top.

STEP 6 Removing the inserts



- There is a lever inside the top cardboard insert that locks it to the printer's frame. Pull the lever to unhook the insert.
 - While pulling the lever, lift the whole insert and remove it.
- ⚠ There are printer parts inside the top cardboard insert! Make sure not to lose them!**

STEP 7 Unpacking the printer



- Use the side handles on the printer to lift it up.
- ⚠ **Do not handle the printer by the top metal profiles!!!** Otherwise, you may warp the printer parts and damage the parts such as the LED lighting inside.
- ⚠ Handle the printer in two people by the sides.
- Hold the bottom of the box while you lift the printer up.

STEP 8 Printer is ready for setup



- Good job! The printer is ready for the next chapter.
- Visit chapter **3. Printer set up**.

3. Printer set up



STEP 1 Tools necessary for this chapter

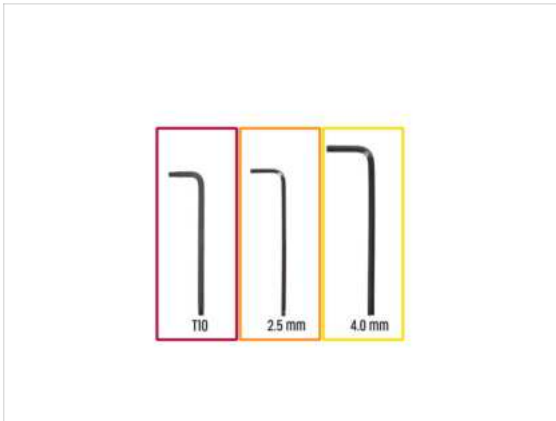

For this chapter, please prepare:

- T10 Torx key

i You can also use a T10 screwdriver, which is included in the package

- 2.5 mm Allen key

- 4.0 mm Allen key

- A cardboard box is to be used as heatbed protection during the setup. *Hint: you can use the Nextruder box shipped with your printer.*

STEP 2 Injection molded xLCD: parts preparation

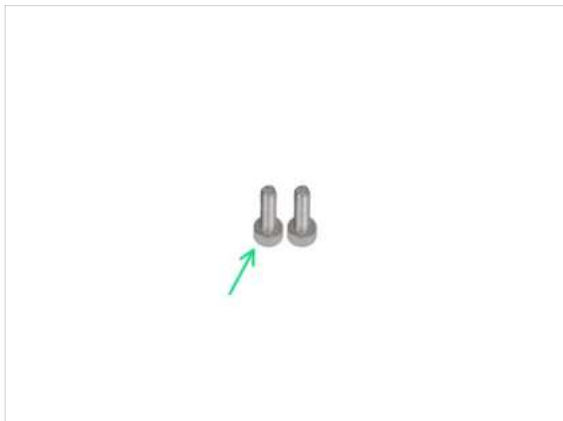

i Starting from September 2024, you may receive a new injection molded xLCD.

For the following steps, please prepare:

- xLCD assembly (1x)

- M3x10 screw (2x)

- If you have an older version (printed) xLCD, continue to the step **xLCD: parts preparation**

STEP 3 Injection molded xLCD: xLCD cables



- ◆ Connect the xLCD cable to the slot on the xLCD board.
 - ⓘ There is a latch on the xLCD cable connector, which must be facing the triangle symbol on the board. See the picture.
- ◆ Push the xLCD cable connector to fully connect to the xLCD. Hold the xLCD cover.
- ◆ Push the earthing connector fully into the PE faston.

STEP 4 Injection molded xLCD: mounting the xLCD



- ◆ Align the xLCD assembly with the nuts in the front aluminum extrusion.
- ◆ Insert and tighten the M3x10 screw from the left side of the xLCD.
- ◆ Insert and tighten the M3x10 screw from the left side of the xLCD.
- ◆ xLCD is ready.

STEP 5 xLCD: parts preparation

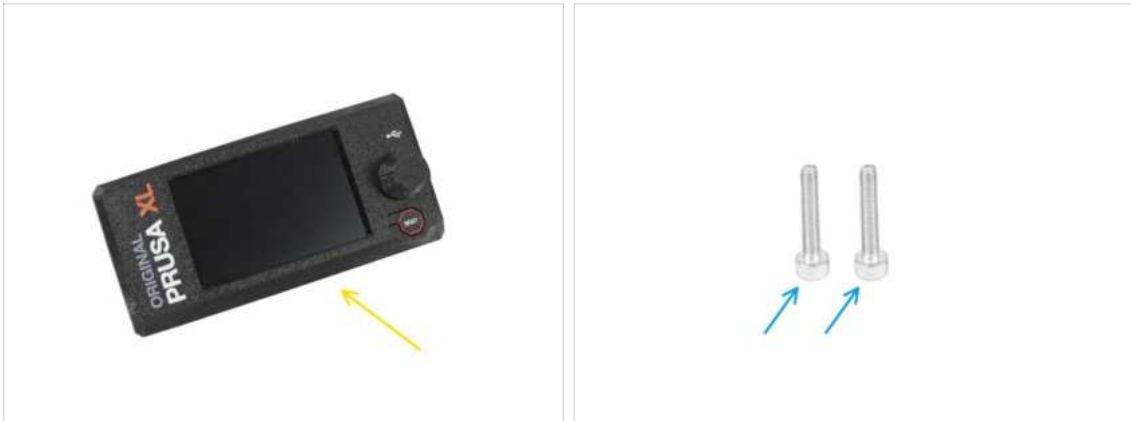

◆ For the following steps, please prepare:

- ◆ xLCD assembly (1x)
- ◆ M3x16 screw (2x)

STEP 6 Mounting the xLCD



- ◆ Carefully turn the printer so that the front side is facing you.
- ◆ From the front of the printer, place the xLCD assembly close to the lower front aluminum extrusion where are the xLCD cables.
- ◆ Connect the xLCD cable to the slot on the xLCD board.
 - ⓘ There is a latch on the xLCD cable connector, which must be facing the triangle symbol on the board. See the detail.
- ◆ Connect the earthing cable and connect it to the PE connector on the xLCD.
- ◆ Push the earthing connector fully into the PE faston.

STEP 7 Mounting the xLCD



- ◆ Align the xLCD assembly with the profile nuts (M3nEs) in the front aluminum extrusion.
- ⓘ Profile nuts (M3nE) are already installed in the aluminum profile by Prusa production department.
- ◆ Insert and tighten the M3x16 screw from the left side of the xLCD.
- ◆ Insert and tighten the M3x16 screw from the right side of the xLCD.

STEP 8 Preparing the printer



- ⚠ **Reminder: To handle the printer, always grab the handles on both sides of the printer. Do not lift the printer by the aluminum extrusions or the metal sheet profiles on top.**
- ⓘ In the following steps, we will work with tools and install extruder above the heatbed, it is recommended to protect it against any possible damage. An empty Nextruder box can serve this purpose.
- ◆ Place the empty cardboard box approximately to the front center part of the heatbed.
- ◆ Manually move the X-axis assembly all the way to the front side of the printer.
- ◆ Manually move the X-carriage approximately to the center of the X-axis.

STEP 9 Nextruder cable: parts preparation



● For the Nextruder cable bundle assembly please prepare:

- Cable bundle (5x)

STEP 10 Preparing the Nextruder dock



● The latest assemblies come with the nozzle seal pre-installed on the extruder dock. To confirm this, examine one of the extruder docks closely and compare it to the picture to see if the nozzle seal is already in place with the square nut. **If not, continue with the text below.**

● **Repeat this step for all tool heads:**

- Insert the M3nS nut into the nextruder dock.
- Push the nut all the way into the dock. If not use the Allen key to push the nut into the nextruder dock.

ⓘ If you didn't find the nut, there is a spare in the Nozzle Seal Assembly package.

STEP 11 Guiding the nextruder cable



- Carefully rotate the printer 180° so that the PSU (Power Supply Unit) side is facing you.
- Locate the long metal profile (tch-mounting-insert) with five M3 holes inside the rear aluminum extrusion.
- We'll use all M3 holes in the metal profile.
- There is a screw in the long metal profile which is fixing the part during the transport. **Keep the screw in the metal profile for now.**
- ⚠ **Maintain the position of the long metal profile for the next step. It must not move!** If the metal profile moves, just push it all the way to the left and fixed it with the screw.

STEP 12 Attaching the first and second nextruder dock



- ◆ Take the cable bundle.
- ◆ Place the xl-dock-cable-router on the bottom metal sheet below the aluminum extrusion.
- ◆ There is a protruding screw from the xl-dock-cable-router. Attach the screw to the first M3 hole in the long metal profile (tch-mounting-insert). Through the hole in the rear metal sheet, check if the cable holder is lined up with the hole.
- ◆ Push the 2.5 mm Allen key all the way through the hole in the rear metal sheet until you reach the **middle** screw in the xl-dock-cable-router and tighten the screw.
- ⚠ **The dock is a press fit, the screw MUST be tightened firmly.**
- ℹ **Repeat this step for the second tool head.**

STEP 13 Dock inspection

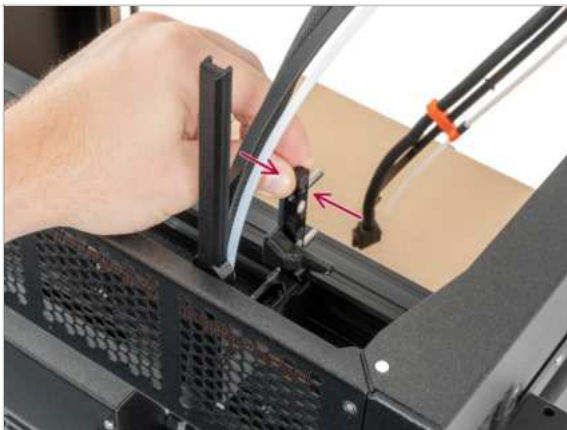

- ⚠ **Check that the dock is properly tightened. The dock must not move.**
- ⚠ **The dock is a press fit, the screw MUST be tightened firmly.**
- ◆ Please watch the video in the next step for a better understanding.

STEP 14 Dock inspection: video

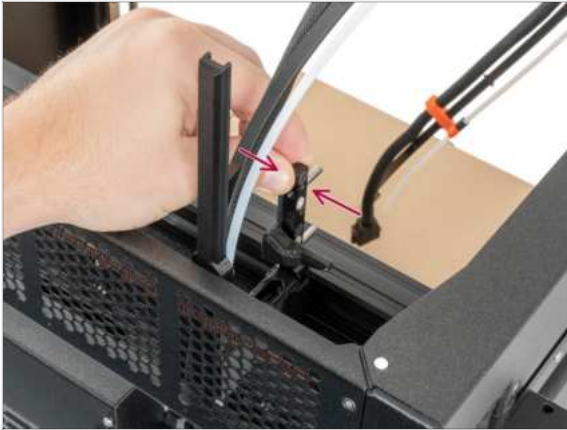

- ◆ The following instructions need to be done correctly and carefully. Achieve better understanding and successful assembly by watching the video alongside the guide.

STEP 15 Third dock: screw removing



- ⓘ At this point you should have already installed two docks.
- ◆ Locate the M3 screw in the metal insert.
- ◆ Using a 2.5mm Allen key, remove the screw from the metal insert.
- ◆ Attach the **third, fourth and fifth** dock the same way as a first dock.
- ⓘ **The dock is a press fit, so the screw needs to be tightened very hard.**
- ◆ The attached docks have to look like in the picture
- ◆ Good job!

STEP 16 Nozzle seal: parts preparation

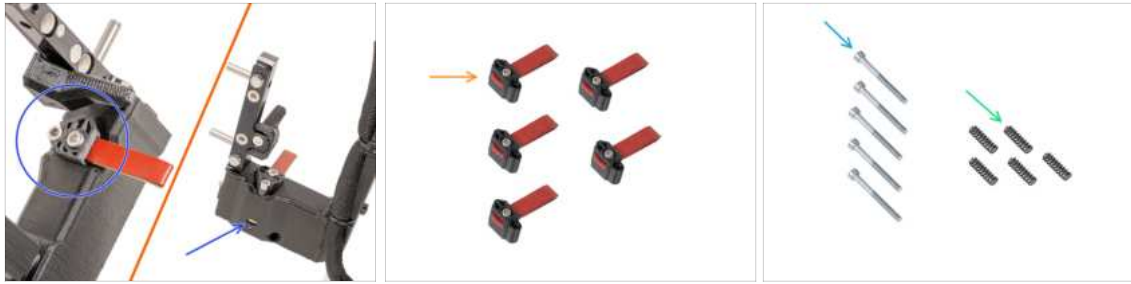

- i Starting from May 2024, you may receive a gray nozzle seal. The assembly and functionality remain identical to the red one.
- **The following instructions are intended only for printers without pre-installed nozzle seals.** If you have already installed the nozzle seals on the nextuder docks, go to **Wi-Fi antenna holder versions**.
- **For the following steps, please prepare:**
 - Nozzle seal (5x)
 - M3x30 screw (5x)
 - Spring 15x5 (5x)

STEP 17 Assembling the Nozzle seal

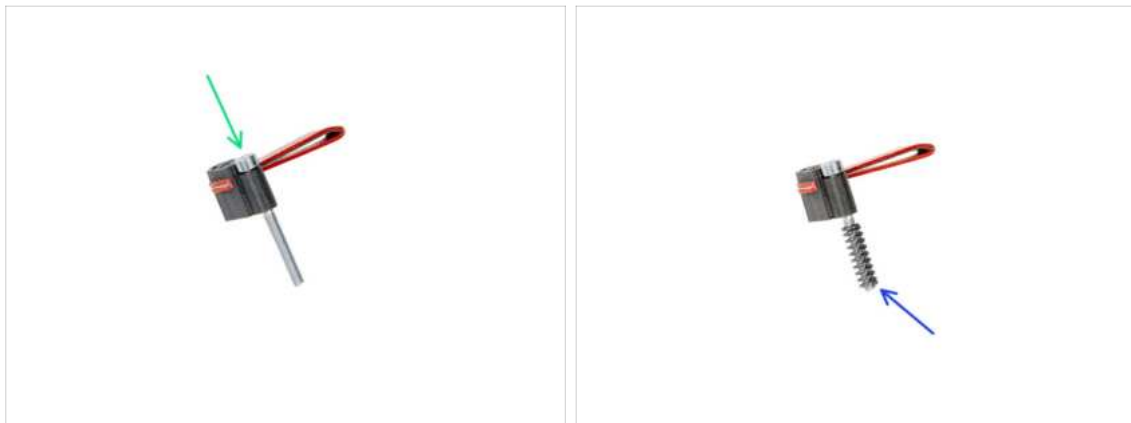

- Insert the M3x30 screw into each nozzle seal.
- Slide the spring on each nozzle seal.
- i **Do this for all five nozzle seals.**

STEP 18 Installing the nextruder nozzle seal



- i** The current nozzle seal position is temporary, the exact height will be set in the next chapter once all the Nextruder parts are mounted.
- The docks have a hole for a nozzle seal.
- Insert the nozzle seal (with the spring) into the dock.
- Using a 2.5 mm Allen key, tighten the screw so that the head of the screw is 1 mm above the dock.
- Good! The first dock is ready.
- i** Repeat this procedure for all remaining docks.

STEP 19 Wi-Fi antenna holder versions



- ① **XL printers feature two distinct Wi-Fi antenna mounts:** one located **on the side** and the other **on the rear side of the printer**. Before proceeding, carefully examine your printer to identify the type of mount it has.
- Begin by verifying that the Wi-Fi mount is pre-installed on the side:
 - **Side mount (Version A):** For printers with the Wi-Fi antenna holder on the side, the **antenna holder comes pre-installed by the Prusa production** department. If your printer has this mount, proceed directly to **(Version A) Connecting the nextruder cables**.
 - If the Wi-Fi mount is not pre-installed on the side:
 - **Rear side mount (Version B):** If the Wi-Fi mount is not pre-installed on the side, your printer may have the rear side mount. In this case, the **antenna holder is not pre-installed by the company**. Navigate to **Version B: Wi-Fi antenna holder: parts preparation** to install the holder and antenna.

STEP 20 Version A: Connecting the nextruder cables



- Locate the xl-rear-cable-management-plug (cover) on the rear of the printer.
- Loosen two screws on the cover slightly. No need to remove them completely. Push the cover to the right and remove it from the printer.
- Connect the first dock (from the right side) cable to the upper slot labeled DWARF 1.
- Connect the second dock (from the right side) cable to the lower slot labeled DWARF 2.
- Attach the connectors cover to the screws. Push it all the way to the left and tighten the screws.

STEP 21 Version A: Removing the XL buddy box cover

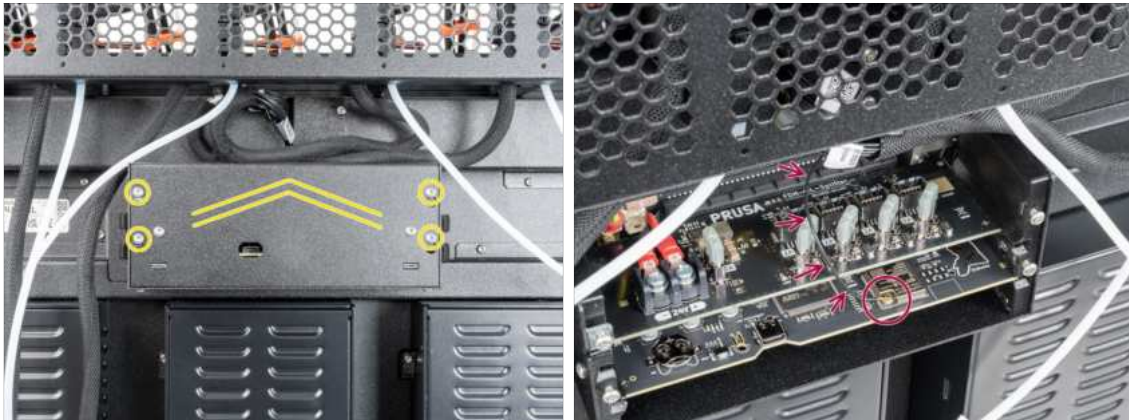

- Loosen four screws on the cover slightly. No need to remove them completely. Push the cover up and remove it from the printer.
- Don't pinch the **antenna cable** while connecting the Nextruders cables!

STEP 22 Version A: Connecting the Nextruder cables



⚠ Do not take the XL-Splitter board out of the printer, the photo is only an illustration of the connector locations.

● Connect the **third, fourth and fifth** (from the right) Nextruder to the XL-Splitter:

● Third Nextruder.

● Fourth Nextruder.

● Fifth Nextruder.

ⓘ XL-splitter with connected Nextruders should look like this.

STEP 23 Version A: Covering the XL buddy box



⚠ Be carefull, do not pinch any cables!

● Put the XL buddy box cover back on the printer.

● Check Nextruder cables, they have to be inside the cutout in the cover.

● With a T10 key tighten the four screws.

STEP 24 Version A: Guiding the PTFE tubes



- 🔴 Locate the side filament sensor.
- 🟢 Insert the PTFE tube from the **first** dock (from the right side) all the way into the upper hole in the part.
- 🟡 Insert the PTFE tube from the **second** dock (from the right side) all the way into the middle hole in the part.
- 🟣 Insert the PTFE tube from the **third** dock (from the right side) all the way into the lower hole in the part.

STEP 25 Version A: Guiding the docks PTFE tubes



- 🔴 Locate the left filament sensor.
- 🟡 Insert the **fourth** dock (from the right side) PTFE tube all the way into the **upper** hole in the part.
- 🟣 Insert the **fifth** dock (from the right side) PTFE tube all the way into the **lower** hole in the part.

STEP 26 Version A: Installing the Wi-Fi antenna: parts preparation



- ◆ **For the following steps, please prepare:**
- ◆ Wi-Fi antenna (1x)
- ⓘ The Original Prusa XL is shipped with two versions of the Wi-Fi antenna, each with a different shape. The functionality is the same.

STEP 27 Version A: Installing the Wi-Fi antenna



- ◆ Locate the Wi-Fi antenna connector on the right rear corner of the printer.
- ◆ The antenna can be rotated around and bent in two directions.
- ◆ We recommend pointing the antenna straight upwards.
- ⓘ Now skip to [Step 35 - Spool holder: parts preparation](#)

STEP 28 Version B: Wi-Fi antenna holder: parts preparation



◆ For the following steps, please prepare:

- ◆ Wi-Fi-antenna-holder version E3/E4 (1x)
- ◆ Antenna cable (1x)

STEP 29 Version B: Installing the Wi-Fi antenna: antenna preparing



- ◆ Remove the nut with the washers from the antenna connector.
- ◆ The antenna connector is prepared.
- ◆ The latest version of the connector has a thicker washer. We don't need it anymore. You can throw it away.
- ◆ Insert the antenna connector into the same-shaped hole in the Wi-Fi-antenna-holder .

STEP 30 Version B: Installing the Wi-Fi antenna: antenna preparing

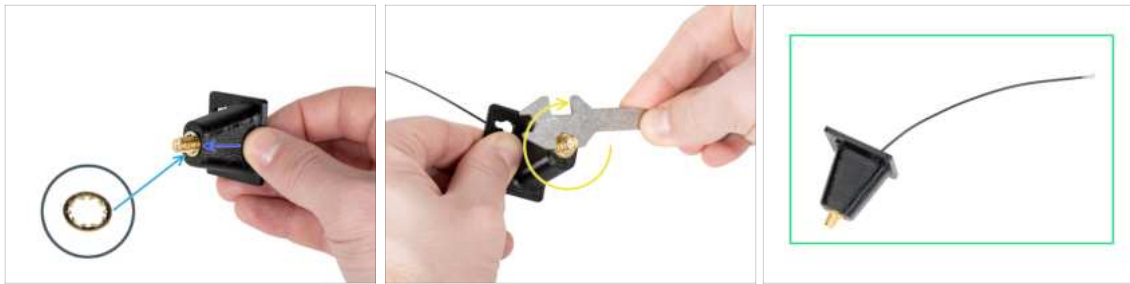

- ◆ Push the antenna connector through the Wi-Fi-antenna-holder.
- ◆ Insert the thinner washer back onto the connector.
- ◆ Using the universal wrench, tighten the nut on an antenna connector.
- ◆ Good job! The Wi-Fi antenna is prepared.

STEP 31 Version B: Connecting the nextruder cables

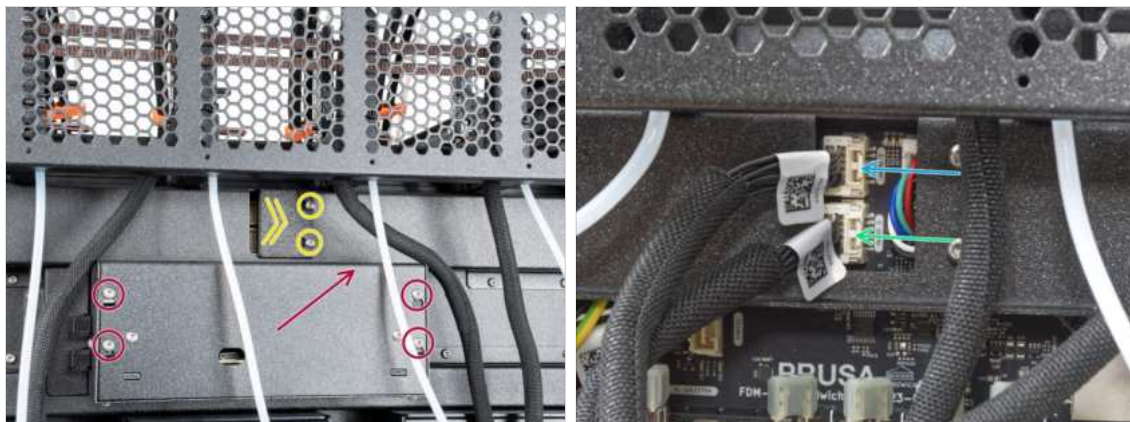

- ◆ Locate the xl-rear-cable-management-plug (cover) on the rear of the printer.
- ◆ Loosen two screws on the cover slightly. No need to remove them completely. Push the cover to the right and remove it from the printer.
- ◆ Loosen four screws securing the electronics cover. Remove the cover.
- ◆ Connect the first dock (from the right side) cable to the upper slot labeled DWARF 1.
- ◆ Connect the second dock (from the right side) cable to the lower slot labeled DWARF 2.

STEP 32 Version B: Installing the Wi-Fi antenna holder



- Push the antenna cable through the opening in the cable cover (metal sheet) and guide it behind the cover to the electronics box.
- Attach the antenna-holder on the screws and push the cover to the left. Tighten the screws.
- Connect the antenna to the appropriate slot on the XL Buddy board.

STEP 33 Version B: Connecting the Nextruder cables





- ⓘ **Do not take the XL-splitter board out of the printer**, the photo is only a tool for connecting the nextruder cables.
- Connect the third, fourth and fifth (from the right) Nextruder to the splitter:
 - Third Nextruder.
 - Fourth Nextruder.
 - Fifth Nextruder.
- XL-splitter with connected Nextruders has to look like this.

STEP 34 Version B: XL buddy box covering







 **Be careful, do not pinch any cables!**

-  Put the XL-buddy-box-cover back on the printer.
-  Check Nextruders cables, they have to be inside the cutout in the cover.
-  With a T10 key tighten the four screws.

STEP 35 Version B: Guiding the docks PTFE tubes



-  Locate the right filament sensor.
-  Insert the **first** dock (from the right side) PTFE tube all the way into the **upper** hole in the part.
-  Insert the **second** dock (from the right side) PTFE tube all the way into the **middle** hole in the part.
-  Insert the **third** dock (from the right side) PTFE tube all the way into the **lower** hole in the part.

STEP 36 Version B: Guiding the PTFE tubes



- ◆ Locate the left filament sensor.
- ◆ Insert the PTFE tube from the **fourth** dock (from the right side) all the way into the upper hole in the part.
- ◆ Insert the PTFE tube from the **fifth** dock (from the right side) all the way into the middle hole in the part.

STEP 37 Version B: Installing the Wi-Fi antenna: parts preparation



- ◆ **For the following steps, please prepare:**
- ◆ Wi-Fi antenna (1x)
 - ⓘ The Original Prusa XL is shipped with two versions of the Wi-Fi antenna, each with a different shape. The functionality is the same.

STEP 38 Version B: Installing the Wi-Fi antenna

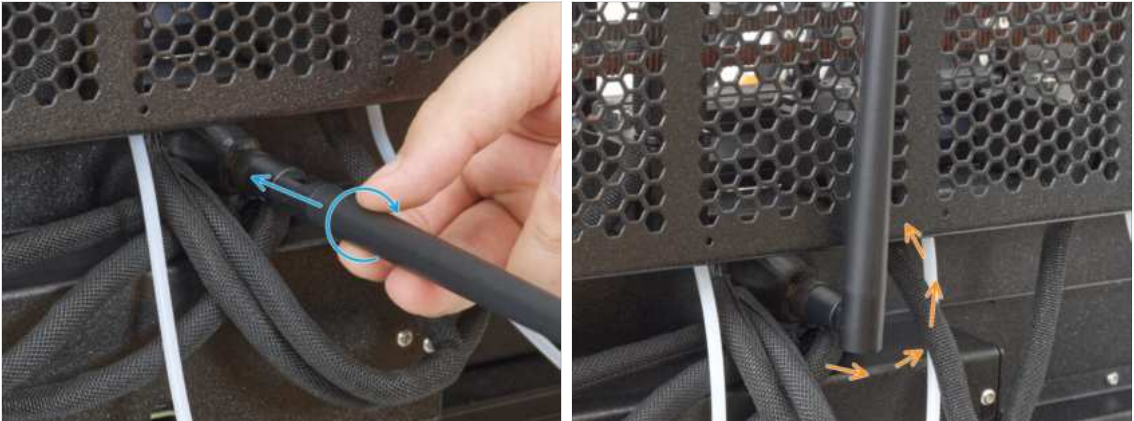

- ◆ Locate the Wi-Fi antenna connector in the middle of the printer.
- ◆ Screw the Wi-Fi antenna on the antenna connector. The antenna can be rotated around and bent in two directions.
- ◆ We recommend pointing the antenna straight upwards.

STEP 39 Spool holder assembly versions



- ⓘ **Original Prusa XL comes with two versions of the spool holder.** Each version has slightly different parts and different procedure.
- ◆ **Refer to the pictures to compare which parts you have, and then choose the instructions that match:**
 - ◆ **Printed spool holder (Version A):** Set of three printed parts. If you have this version, continue to the **Version A: Spool holder: parts preparation**.
 - ◆ **Injection molded spool holder (Version B):** Set of two injection molded parts. If you have this version, continue to **Version B: Assembling the spool holder: parts preparation..**

STEP 40 Version A: Spool holder: parts preparation



● For the following steps, please prepare:

- Spool-holder-slider (5x)
- Spool-holder-base (5x)
- Spool-holder-mount (5x)
- M5x85 screw (5x)
- M5nEs nut (5x)

STEP 41 Version A: Spool holder: left side



- Carefully turn the printer so that the side with the Wi-Fi antenna faces you.
- Insert the M5nEs nut into the front support extrusion (with the orange plastic cover). Insert the side with the spring (metal plate) first, then push the nut inside.
- The M5nEs nut is free to move, you can adjust the position as you want. But remember, the nut must be slightly pushed in to smoothly move. Anyway, we recommend approximately the same position as you can see in the picture.
- Insert **second** and **third** M5nEs nut in the extrusion approximately to the same position as shown.

STEP 42 Version A: Assembling the spool holder

◆ **Repeat this step for all five spool holders:**

- ◆ Insert the spool-holder-base into the spool-holder-slider and push it through a little through the part.
- ◆ Attach the spool-holder to the spool-holder-mount.
- ◆ Insert the M5x85 screw into the spool-holder-assembly.

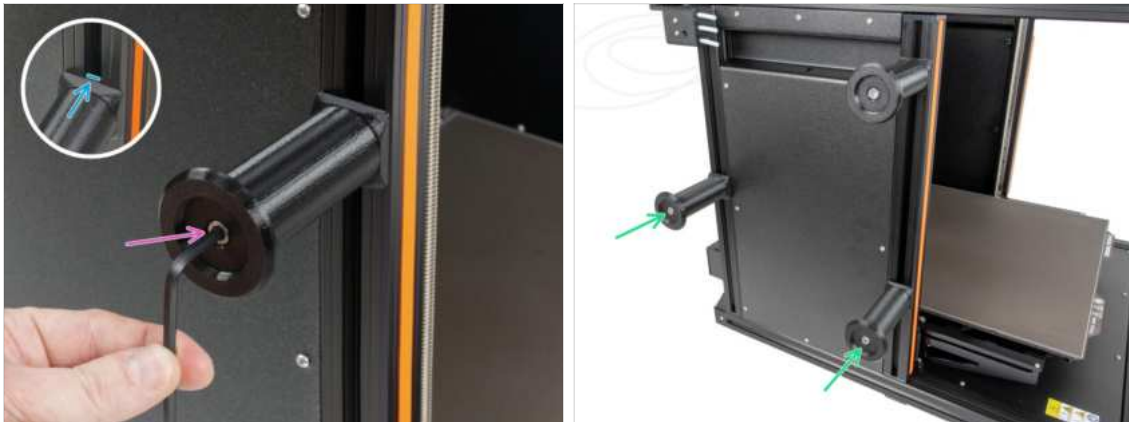
STEP 43 Version A: Mounting the spool holder assembly

- ◆ Attach the spool holder assembly to the M5nEs nut in the extrusion. Note that there is a protrusion on the spool-holder-mount, which must fit into the groove in the extrusion.
- ◆ Tighten the spool holder assembly with a 4 mm Allen key.
- ◆ Attach and tighten the second and the third spool holder to the M5nEs nut using a 4 mm Allen key.

⚠ **Do not use the spool holder as a handle!**

- ⓘ Keep in mind that if you mount the Spool holder too high or too low, it may not fit the filament spool on it. There has to be enough space around it.

STEP 44 Version A: Spool holder: right side assembly



- Carefully turn the printer so that the side without the Wi-Fi antenna faces you.
- Insert the fourth and fifth M5nEs nut in the extrusion approximately to the same position as shown.
- Attach and tighten the fourth and the fifth spool holder to the M5nEs nut using a 4 mm Allen key.
- ⚠ **Do not use the spool holder as a handle!**
- ⓘ Keep in mind that if you mount the Spool holder too high or too low, it may not fit the filament spool on it. There has to be enough space around it.
- Now, go to **Nextruder assembly: parts preparation**.

STEP 45 Version B: Assembling the spool holder: parts preparation



- For the following steps, please prepare:
- Spool-holder-slider 5x)
- Spool-holder-base (5x)
- M4x12 screw (5x)
- M4nEs nut (5x)

STEP 46 Version B: Assembling the spool holder: adjusting the nut



- Carefully turn the printer so that the side with the Filament sensor (with 3 PTFE tubes) is facing you.
- Insert the first M4nEs nut into the front support extrusion (with the orange plastic cover). Insert the side with the spring (metal plate) first, then push the nut inside.
- Insert the second and the third M4nEs nut into the extrusions as described in the picture.
- The M4nEs nuts are free to move, you can adjust the position as you want. But remember, the nuts must be slightly pushed in to smoothly move. Anyway, we recommend approximately the same position as you can see in the picture.

STEP 47 Version B: Assembling the spool holder



- Locate pins two pins on the spool-holder-base and line them with the rails in the spool-holder-slider.
- Insert the spool-holder-base into the spool-holder-slider and push it through a little through the part.

STEP 48 Version B: Preparing the spool holder



- ✦ Insert the M4x12 screw on the longer side of the 3mm Allen key.
- ✦ Insert the 3mm Allen key with the M4x12 screw through the assembled spool holder to the prepared hole in the spool-holder-base.
- ✦ The M4x12 screw has to protrude through the spool-holder-base.

STEP 49 Version B: Spool holder: left side assembly



- ✦ Attach the first spool holder assembly to the M4nEs nut in the extrusion. Note that there is a protrusion on the spool-holder-base, which must fit into the groove in the extrusion.
- ✦ Tighten the spool holder assembly.
- ✦ Assemble the second and the third spool holder and attach them to the M4nEs nuts with M4x12 screws.

 **Do not use the spool holder as a handle!**

STEP 50 Version B: Spool holder: right side assembly



- Turn the printer, so the Filament sensor (with two PTFE tubes) is facing you.
- Insert the fourth and fifth M4nEs nut in the extrusion approximately to the same position as shown.
- Attach and tighten the fourth and the fifth spool holder to the M4nEs nut using a 3 mm Allen key.
- ⚠ **Do not use the spool holder as a handle!**
- ⓘ Keep in mind that if you mount the Spool holder too high or too low, it may not fit the filament spool on it. There has to be enough space around it.

STEP 51 Nextruder assembly: parts preparation



- For the next steps, please prepare:
 - Nextruder (5x)

STEP 52 Docking the Nextruder

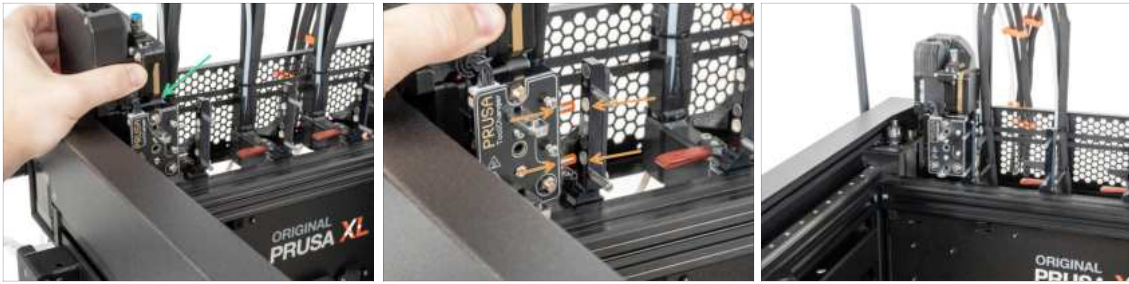

- Take the Nextruder and place it carefully next to the dock.
- Place the two metal inserts through the white holes in the dock. The magnets will help you dock the Nextruder.
- Well done, the first Nextruder is ready!
- Dock the **second, third, fourth** and fifth Nextruder in the same way as the first.

STEP 53 Nextruder cable bundle assembly



- **Repeat this step for all tool heads:**
 - Take the first nextruder cable bundle.
 - ⚠ **Check that the cable bundle is not twisted!**
 - Hook up the keyhole openings in the flexible plate of the cable bundle onto the screw heads and push it up to correct the position.
 - Hold the Nextruder and using a T10 key tighten the marked two screws.

STEP 54 Nextruder cable bundle assembly



◆ Repeat this step for all tool heads:

- ◆ Attach the cable connector into the top of the Nextruder.
 - ◆ Insert the semi-transparent PTFE tube into the fitting on the Nextruder. Push it all the way in.
- ⓘ Starting from September 2024, you may receive a new black Fitting M5-4. The assembly and functionality remain identical to the blue one.
- ◆ Good job!

STEP 55 Almost done!



- ◆ **Congratulation!** Your Original Prusa XL is ready to be fired up!
- ◆ Compare the final look with the picture.
- ◆ Now, let's go to the last chapter 5. **First run.**

5. First run



STEP 1 Before you start with Multi-Tool



- i** This chapter shows a brief description of the wizard. Please note that the screenshots are illustrative and might differ from those in the firmware.
- i** Make sure you are running **Firmware 5.1.2 or newer**
- i** Some parts of the wizard must be done multiple times, this depends on the number of tool-heads. For example:
 - ◆ Dock Calibration
 - ◆ Loadcell calibration
 - ◆ Filament sensor calibration

STEP 2 Preparing the printer



- ⚠** Make sure that the printer is placed in a stable place where no ambient vibrations are transmitted (for example, where other printers are printing).
- ◆ From the rear side of the printer, plug in the PSU cable.
- ◆ Turn the power switch ON (symbol "I").

STEP 3 Prusa Nextruder sock (Optional)



- ◆ A silicone sock is supplied with each Nextruder package.
- ◆ If you want to install the sock, **do it before the calibration.**
- ⓘ How to install the sock - [check the article.](#)

STEP 4 Nozzle seal height calibration

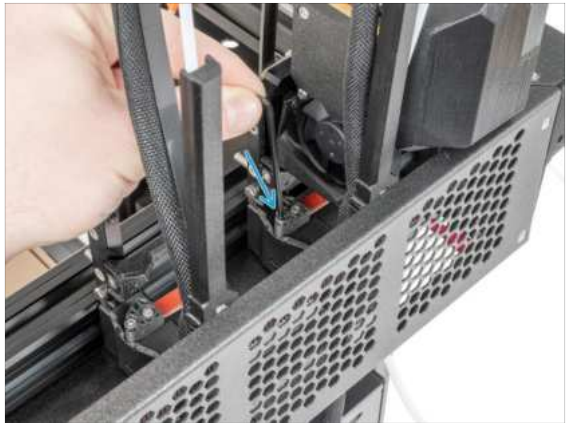

- ⓘ Starting from May 2024, you may receive a gray nozzle seal. The assembly and functionality remain identical to the red one.
- ◆ On the Nozzle seal height calibration steps were used docked Nextruder without the printer for better visibility, proceed next steps on your printer. **Do not dismantle the docks.**
- ◆ In the next step, we'll calibrate the height of the nozzle seal.
- ◆ Using the 2.5 mm Allen key, tighten or untighten the M3x30 screw to calibrate the height of the nozzle seal.
- ◆ Proceed to the next step.

STEP 5 Nozzle seal height calibration



- ◆ If the Nozzle seal is too low or too high, we need to reposition its height.
- ◆ Using a 2.5 mm Allen key:
 - Turn the M3x30 screw clockwise to set the Nozzle seal lower.
 - Turn the M3x30 screw counterclockwise to set the Nozzle seal higher.
- ◆ The correct position of the Nozzle seal is, that the Nozzle seal isn't bent and it is touching the nozzle.

STEP 6 Wizard



- ◆ After the printer starts up, the screen prompts for the printer test and setup wizard.
- ① The wizard will test all important components of the printer. The whole process takes a few minutes. Some parts of the wizard require direct user interaction. Follow the instruction on the screen.
- ⚠ **NOTE: While testing the axes, make sure that there is nothing in the printer that is obstructing the movement of the axes.**
- ⚠ **WARNING: Do not touch the printer during the wizard unless prompted! Some parts of the printer may be HOT and moving at high speed.**

STEP 7 Wizard: Dock Position Calibration

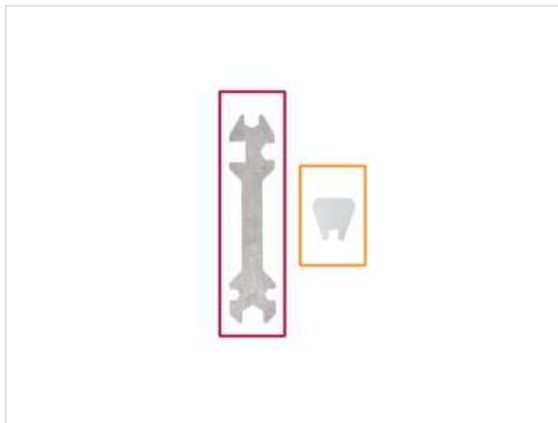

● You will need:

- Universal wrench (1x)
- Mini wrench (1x)

● Dock calibration will guide you through how to properly calibrate the position of individual tool heads on the printer.

⚠ It is necessary to follow every step in the dock calibration properly! **Do not rush, read every step twice, then proceed with the instruction.**

STEP 8 Wizard: Loosen pin

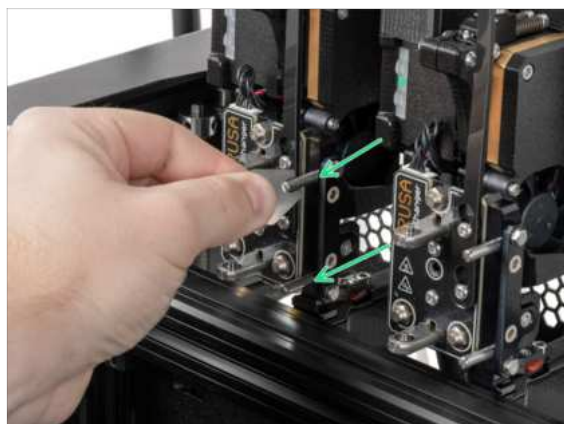

● Follow the wizard instructions on the screen.

● Using a Mini wrench, unscrew both dock pins on Dock 1.

STEP 9 Wizard: Loosen screws



- Follow the wizard instructions on the screen.
- Using a Uni wrench, loosen two screws. **A few turns are enough.**

STEP 10 Wizard: Lock the tool

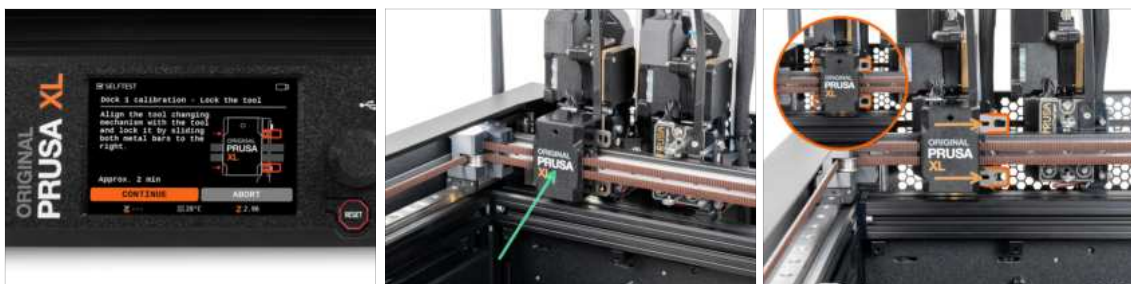

- Follow the wizard instructions on the screen.
- Manually move the Tool changing mechanism to the first tool.
- Manually lock the metal bars as described in the picture.
- ⚠ **The tool has to be locked in the tool changer.**

STEP 11 Wizard: Tighten the upper screw

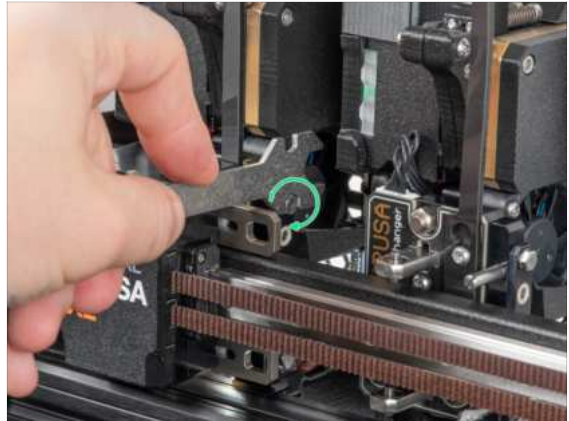

- ◆ Follow the wizard instructions on the screen.
- ◆ Using a Uni wrench, tighten the upper screw on a side of the dock.
- ⚠ After confirming by the *continue* button on the LCD, the XY axis will leave the dock with the tool. **Clear the space.**

STEP 12 Wizard: Tighten the lower screw

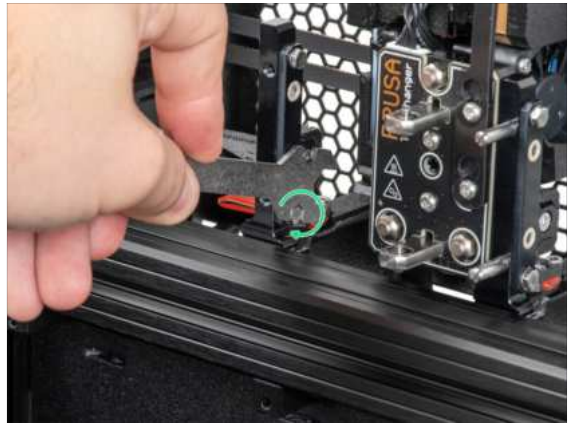

- ◆ Follow the wizard instructions on the screen.
- ◆ Using a Uni wrench, tighten the lower screw on a side of the dock.

STEP 13 Wizard: Install pins

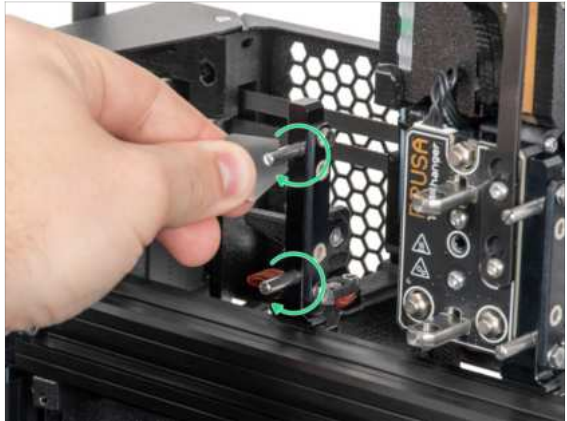

- Follow the wizard instructions on the screen.
- Insert the two metal pins and tighten them with a Mini wrench.
- After clicking on the *continue* button on the LCD, the printer will put back the tool into the dock1 and do a few calibration moves.

STEP 14 Wizard: Dock successfully calibrated

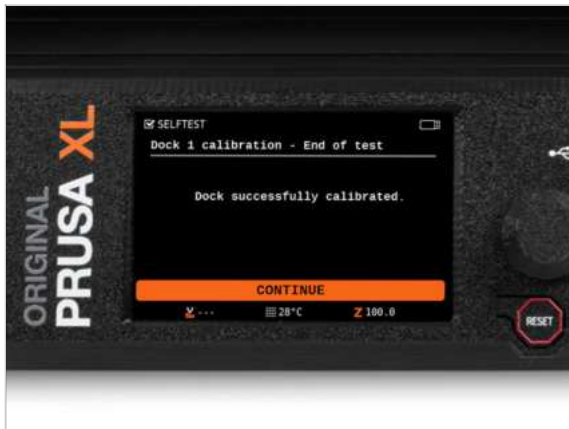

- Good job! The Dock1 is calibrated.
- According to the number of print heads, the dock calibration process is repeated.

STEP 15 Wizard: Loadcell test



- ◆ The next step of the wizard will prompt you to touch the nozzle to test and calibrate the **Loadcell**. During this procedure, the parts of the printer are not heated, you can touch the parts of the printer. Click on **Continue**.
- ⓘ You can look at the nozzle while you wait, the printer will make a sound when you need to touch the nozzle.
- Do not touch the nozzle yet, wait until prompted with the message: **Tap the nozzle NOW**.
- Slightly tap the nozzle. No need to use extra force. In case the Loadcell does not detect enough touch, you will be prompted to repeat the step. Otherwise, you will see **Loadcell test passed OK** when it succeeds.
- According to the number of print heads, the loadcell test process is repeated.

STEP 16 Wizard: Calibrate Filament Sensors



- During the calibration of the filament sensors, you will be prompted to use at least 130 cm of filament. *Hint: Use the Prusament shipped with your printer and hang it directly on the spool holder.*
- ◆ When you have prepared the filament, click on **YES**.
- Wait for the printer to prompt you to insert the filament into the side filament sensor.

STEP 17 Wizard: Calibrate Filament Sensors

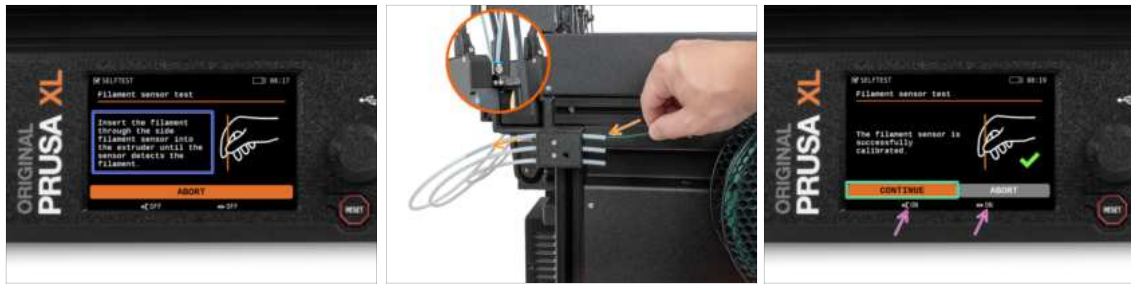

- Now, insert the filament into the side filament sensor and push it until it reaches the filament sensor in the extruder (you will feel a slight resistance).
- You can check the side filament sensor (left) and extruder filament sensor (right) status on the bottom bar on the screen.
- i According to the number of print heads, the filament sensor calibration is repeated.
- All filament sensors are successfully calibrated and tested. Click on **CONTINUE**.

STEP 18 Calibration pin: parts preparing



- For the next step, please prepare:
 - Calibration pin (1x)
 - Calibration-pin-key (1x)

STEP 19 Calibration pin: parts assembly

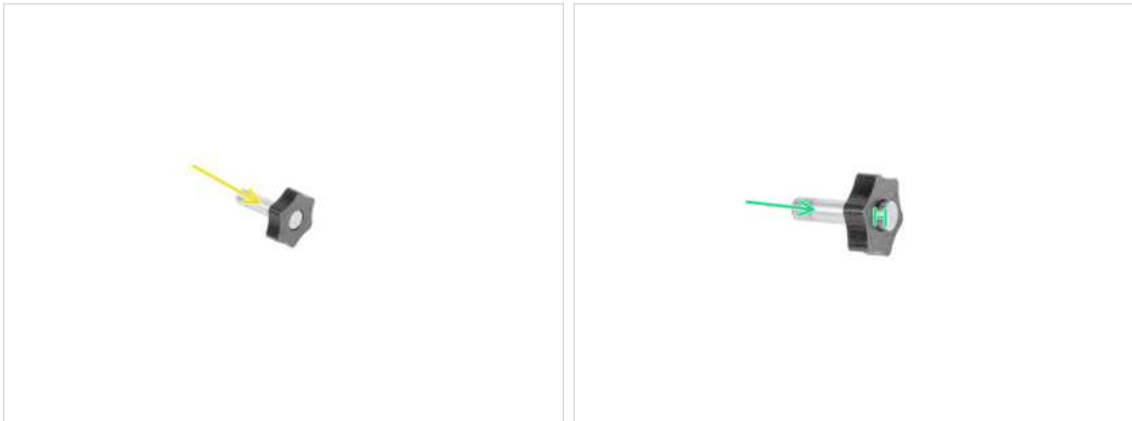

- Insert the calibration pin into the plastic part.
- Push the pin into the plastic part, so it will make a small gap on top.
- Well done, the pin is prepared.

STEP 20 Wizard: Tool Offset Calibration

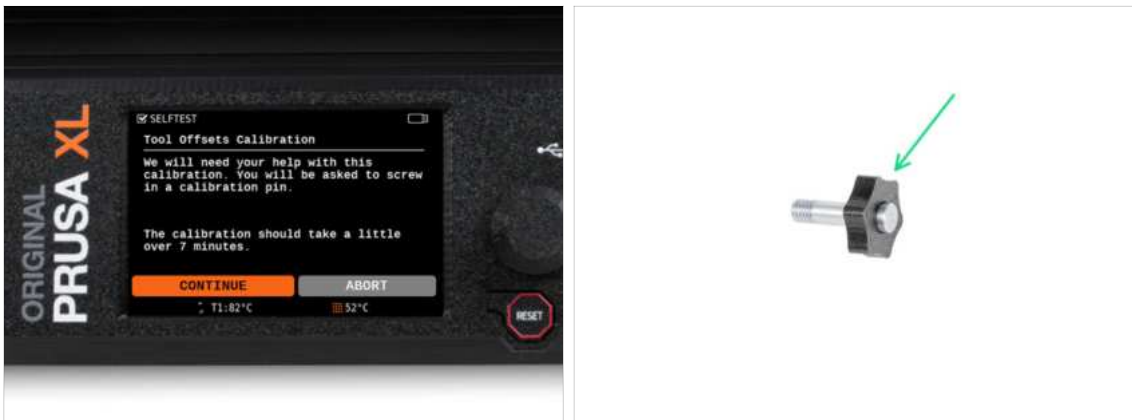

- During offset calibration, you will need to screw the calibration pin into the center of the heatbed.
- Click on *Continue* to start the Tool Offsets Calibration.
- Calibration pin (1x)

STEP 21 Wizard: Sheet install



- ◆ Follow the wizard instructions on the screen.
- ◆ Put the print sheet onto the heatbed.
- ⓘ Now, the printer starts short calibration.

STEP 22 Wizard: Calibration pin installation



- ◆ Follow the wizard instructions on the screen.
- ◆ Take off the print sheet from the heatbed.
- ◆ Install the calibration pin into the middle of the heatbed. Turn the pin clockwise.
- ⓘ Now, the printer will calibrate all the tool heads.

STEP 23 Wizard: Offset calibration done



- ◆ Follow the wizard instructions on the screen.
- ◆ Untighten the calibration pin from the heatbed and take it off. Rotate counterclockwise.
- ◆ Place the print sheet onto the heatbed.
- ◆ (i) The printer will finish the calibration.
- ◆ Good job! The Offset calibration is done.

STEP 24 Calibration pin



- ◆ Insert the calibration pin into the left side filament sensor.

STEP 25 It's done

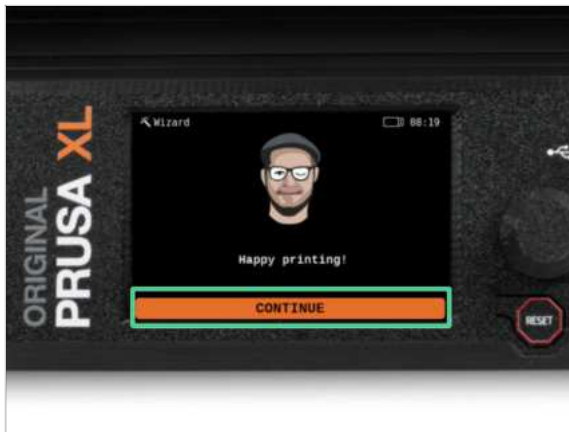

- ◆ **That's all, the printer is ready to print.** But still, follow the instructions in this manual to the end.

STEP 26 Regular printer maintenance

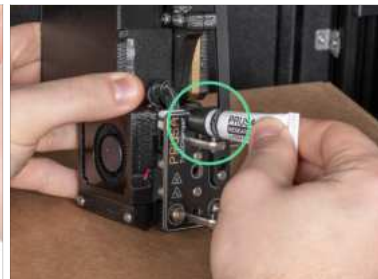

- ① To keep your printer working properly over time, it is highly recommended to do regular maintenance.
- ◆ For regular printer maintenance, follow the [Regular printer maintenance \(XL\)](#) article for information and instructions.
- 📌 On multi-tool printers, it is necessary to focus on lubricating the coupler pins of the ToolHeads.
 - ① Lubricating the coupler pins can be made along with the rest of the maintenance, or it can also be done if you notice that your prints have banding or ringing issues.
 - ◆ To lubricate the coupler pins use our dedicated online guide [How to lubricate the coupler pins on Original Prusa XL](#).
 - ① You will need to print an applicator to lubricate the pins. Please refer to the dedicated guide for more information.

STEP 27 Quick guide for your first prints



Now, please read the **3D Printing Handbook**, which is tailor-made for your printer and **follow the instructions to set up the printer properly**. The latest version is always available at [this link](#).



Read the chapters *Disclaimer* and *Safety instructions*.

STEP 28 Printable 3D models

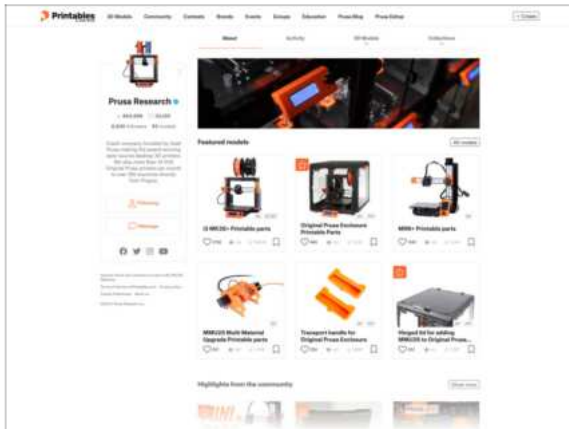

Congratulations! You should be ready to print by now ;-)



You can start by printing some of our test objects bundled on the included USB stick - you can check them out [in this collection](#).

STEP 29 Prusa knowledge base

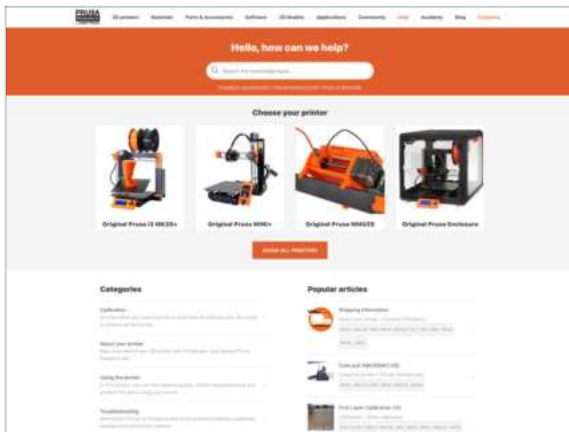

- ◆ If you encounter any problems at all, don't forget you can always check out our knowledge base at help.prusa3d.com
- ◆ We're adding new topics every day!

STEP 30 Join Printables!



- ◆ Don't forget to join the biggest Prusa community! Download the latest models in STL or G-code tailored for your printer. Register at [Printables.com](https://printables.com)
- ◆ Looking for inspiration on new projects? Check our blog for weekly updates.
- ◆ If you need help with the build, check out our forum with a great community :-)
- ⓘ All services share one account.

Manual changelog Five-Head (Assembled)

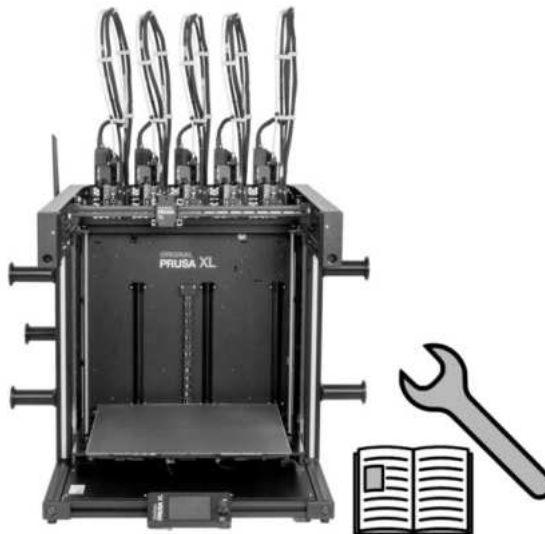

STEP 1 Version history

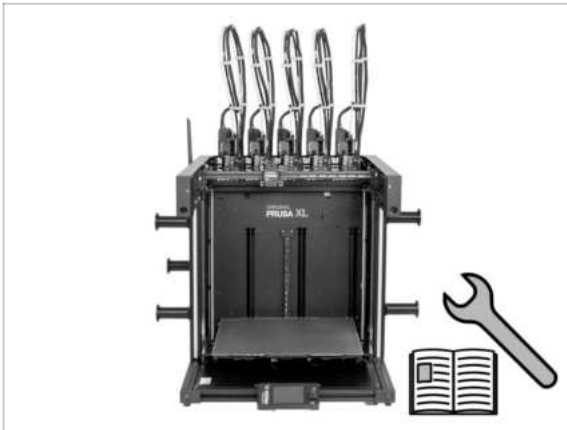

- ◆ **Versions of the Original Prusa XL semi-assembled (single tool) manual:**
- ◆ 06/2023 - Initial version 1.00
- ◆ 07/2023 - Updated to version 1.02
- ◆ 08/2023 - Updated to version 1.03
- ◆ 11/2023 - Updated to version 1.04
- ◆ 05/2024 - Updated to version 1.05
- ◆ 09/2024 - Updated to version 1.06

STEP 2 Changes to the manual (1)

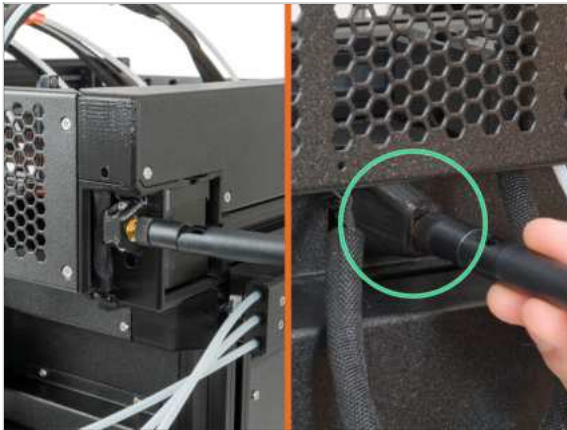

- ◆ 08/2023 - Antenna adapter
 - ◆ Added instructions for the new antenna adapter.
- ⓘ Manual version 1.01

STEP 3 Changes to the manual (2)

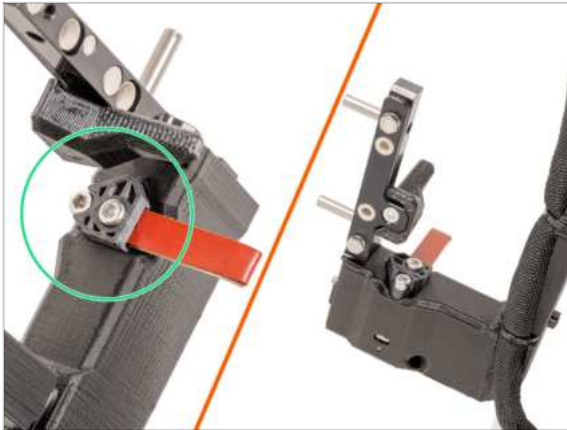

- 08/2023 - Nextrunder dock
- Added instructions for the new dock.
- ⓘ Manual version 1.02

STEP 4 Changes to the manual (4)



- 11/2023 - Spoolholder
- Added instructions for the new injection molded Spoolholder.
- Manual version 1.04

STEP 5 Changes to the manual (5)

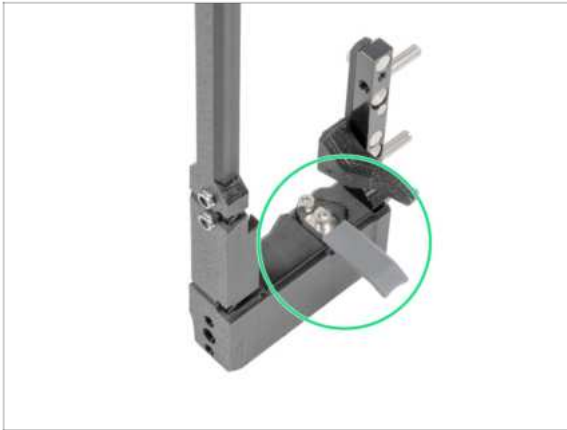

- 05/2024
 - Added information about the new gray nozzle seal.
- Manual version 1.05

STEP 6 Changes to the manual (6)



- 09/2024 - xLCD
 - Added instructions for the new injection molded xLCD.
- Manual version 1.06







