

Dear customer,

Congratulations on choosing the Noctua NF-A20 FLX.

Our fans are renowned for their impeccable quality and outstanding longevity and like all Noctua fans, the NF-A20 FLX features an MTTF rating of more than 150.000 hours that's backed up with our 6 years manufacturer's warranty.

Each Noctua fan is double checked for flawless operation by our quality control team before it leaves the factory and I'm confident that you will be able to sense some of the research, attention and care we've put into making this product.

Enjoy your NF-A20 FLX!

Yours sincerely,

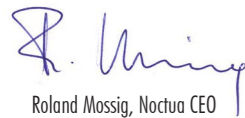

Roland Mossig, Noctua CEO

This document includes some instructions for installing, running and cleaning your NF-A20 FLX.

Should you have any further questions, our support team (support@noctua.at) will be glad to assist you at any time.

*Please also have a look at the regularly updated FAQs on our website:
<http://www.noctua.at/faqs>*

*This document is also available in other languages at the following URL:
<http://www.noctua.at/manuals>*



Scan this code to display multi-lingual manuals on your mobile phone.

Designed in Austria, Noctua's premium cooling components are internationally renowned for their superb quietness, exceptional performance and thoroughgoing quality.

Having received more than 6000 awards and recommendations from leading hardware websites and magazines, Noctua's fans and heatsinks are chosen by more than a hundred thousand satisfied customers around the globe.

sales@noctua.at | www.noctua.at



Hole spacing

In order to ensure broad compatibility with today's PC cases, the NF-A20 FLX features three sets of mounting holes: While the 154x154mm and 110x180mm spacing allow it to replace most 200mm fans, the 170x170mm spacing is used by many 230mm and 250mm fans, which can thus also be replaced by the NF-A20 FLX.

As there is no fixed industry standard for the size or hole spacing of 200mm, 220mm, 230mm or 250mm fans, please carefully check both the hole setup of your chassis and the available space (the NF-A20 FLX is 30mm thick whereas some other 200mm fans are only 20mm or 25mm!) in order to verify that the NF-A20 FLX is compatible with your chassis.

In case of doubt, please contact your chassis manufacturer.

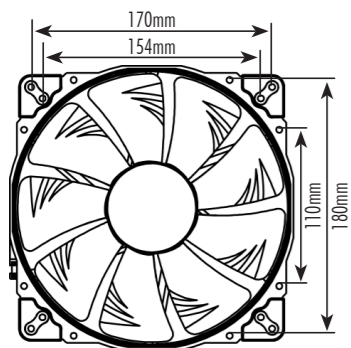

Installation

The NF-A20 FLX includes both standard case fan screws and two types of silicone anti-vibration mounts for installation.

While the double-sided NA-AV3 mounts are more convenient to install in space-restricted environments, the NA-AV4 mounts with flat case-side end are flush with the case panel and thus look tidier from the exterior.

If necessary, you can easily remove the NF-A20 FLX's integrated anti-vibration pads:

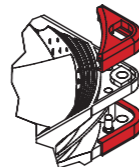

NA-AV3 Double-side design with long case-side end



NA-AV4 Flat case-side end



For installing the fan using the **NA-AV3** mounts:

- 1 Please first pull the F side through the fan's mounting holes until pawl 1 is all the way through the first hole.

Caution: Only pull pawl 1 through the first hole. Don't overstretch the mounts by pulling pawl 5 through the opposite hole!

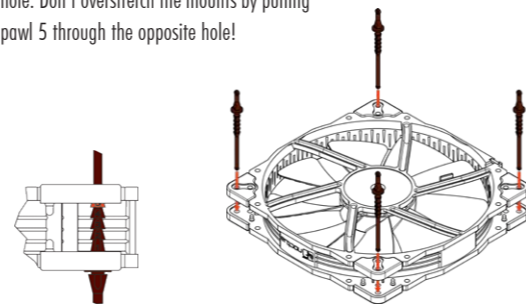

- 2 Then pull the C side through the mounting holes of the case.

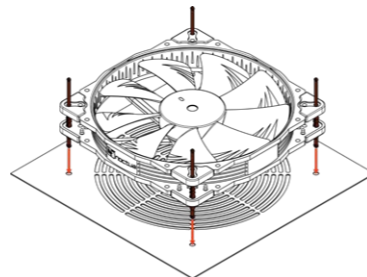

For installing the fan using the **NA-AV4** mounts:

- 1 Please first pull the NA-AV4 through the mounting holes of the case.

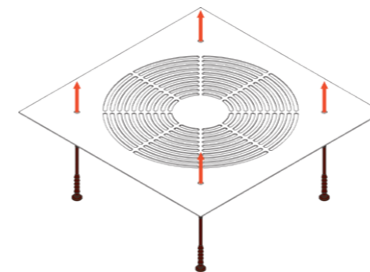

- 2 Then pull the tip through the fan's mounting holes until the pawl 1 is all the way through the hole.

Caution: Only pull pawl 1 through the first hole. Don't overstretch the mounts by pulling pawl 5 through the opposite hole!

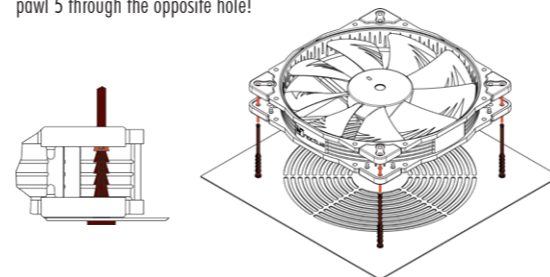

If the long ends of the mounts are in the way, you can use scissors to cut them after installation.

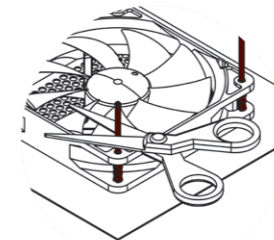

Note that this will then make them difficult to reinstall in the future.

Connection

The NF-A20 FLX features a standard 3-pin fan connector. Please note that the fan can also be connected to 4-pin motherboard fan headers though. If you would like to connect the fan directly to your power supply, please use the supplied 3-4-pin adaptor (NA-AC1).

The NF-A20 FLX features a short 20cm primary cable in order to help you minimise cable clutter in typical applications. If you need a longer cable, please add the supplied 30cm extension (NA-EC2).

The NF-A20 FLX comes with a Low-Noise Adaptor (NA-RC13) that allows you to reduce the fan speed from 800 to 550rpm in order to achieve even quieter operation.

Cleaning and Maintenance

Fans inside computer cases tend to accumulate dust over longer periods of usage. In order to maintain maximum performance, please clean your fans regularly using a duster, slightly moist tissue or canned air. Please be careful not to use too much force in order to prevent any damage to the fan. Please don't use a vacuum cleaner as this may apply excessive force to the fan.

In order to ensure flawless operation over many years of usage, the NF-A20 FLX's premium grade SSO2 bearing is fully sealed to prevent the entering of fine dust particles.

Please note that the fan is not designed to be taken apart by the user. Removing the impeller from the frame will break the sealing of the bearing and results in a loss of warranty.

Warranty and Support

Even with high-grade products and strict quality control, the possibility of defects cannot be eliminated entirely. Therefore, we aim at providing the highest possible level of reliability and convenience by offering a warranty period of 6 years and direct, fast and straightforward RMA service.

Should you encounter any problems with your NF-A20 FLX, please don't hesitate to contact our support team (support@noctua.at).